

OCS

DIVE COMPUTER

OPERATING MANUAL

CONTENTS

NOTICES.....	3	DIVE MODE FEATURES	24
FEATURES AND FUNCTIONS.....	5	WET ACTIVATION	25
DISPLAY LAYOUT.....	6	BACKLIGHT	25
ABBREVIATIONS.....	6	BAR GRAPHS	25
INITIAL ACTIVATION.....	6	TLBG.....	25
OVERVIEW.....	7	O2BG	25
MENU SYSTEM.....	7	VARI	25
OPERATING MODE STRUCTURES	8	ALGORITHM.....	26
AUDIBLE ALARM.....	9	CONSERVATIVE FACTOR.....	26
PC INTERFACE.....	9	DEEP STOP	26
POWER SUPPLY, LOW BATTERY	10	SAFETY STOP.....	26
WATCH MODE.....	11	OVERVIEW OF FO2 SETTINGS AND 50% DEFAULT	26
WATCH DEFAULT TIME.....	12	FO2 50% Default.....	26
WATCH MENU.....	12	FO2 set for Air.....	27
Countdown Timer.....	12	FO2 set for Nitrox	27
Chronograph.....	13	DIVE TIME REMAINING (DTR).....	27
Daily Alarm.....	13	No Deco DTR (NDC)	27
Set Time Menu	14	O2 DTR (OTR)	27
Set Date Format.....	14	ERROR (RESET DURING DIVE).....	27
Set Hour Format	14	NORM DIVE MODES	28
Select Default Time	14	NO DECO MAIN AND ALTS.....	29
Set Alternate Time	14	DEEP STOP	29
Set Time	14	SAFETY STOP.....	30
Set Date	14	DECOMPRESSION	30
NORM SURFACE MODES	16	VIOLATION MODES.....	31
Dive Computer Operating Modes	17	HIGH PO2	33
Post Dive.....	17	HIGH O2.....	34
NORM SURF MAIN AND ALTS.....	18	GAS SWITCHING	36
NORM MENU.....	18	DIGITAL GAUGE MODE	39
Fly/Desat Time	18	GAUG SURFACE MAIN AND ALTS.....	40
NORM Plan Mode	19	GAUG MENU	40
NORM/GAUG Log Mode.....	19	Fly Time.....	40
Set F (FO2) Menu.....	20	Run Timer.....	40
Set Gas 1 FO2/PO2 Alarm.....	20	GAUG DIVE MAIN AND ALT	41
Set Gas 2 FO2/PO2 Alarm.....	21	Delayed Violation.....	41
Set Gas 3 FO2/PO2 Alarm.....	21	FREE DIVE MODE.....	42
Set FO2 Default.....	21	FREE SURFACE MAIN AND ALTS.....	43
Set A (Alarms) Menu.....	21	FREE MENU	44
Set Audible Alarm.....	21	Countdown Timer.....	44
Set Depth Alarm.....	21	Set CDT	44
Set EDT Alarm.....	21	Elapsed Dive Time Alarm.....	44
Set TLBG Alarm.....	22	Set EDT Alarm.....	44
Set DTR Alarm	22	Descending Depth Alarms.....	44
Set U (Utilities) Menu	22	Set DD Alarms.....	44
Set Wet Activation	22	Select Dive Mode.....	45
Set Units.....	22	FREE DIVE MAIN AND ALTS.....	46
Set Deep Stop.....	22	FREE DIVE ALARMS	46
Set Safety Stop.....	22		
Set Algorithm	22		
Set Conservative Factor	23		
Set Glo (Backlight) Duration	23		
Set Sampling Rate.....	23		
Select Dive Mode.....	23		
NORM/GAUG History Mode.....	23		
Serial Number.....	23		

CONTENTS (continued)

COMPASS MODE.....	48
OVERVIEW	49
COMPASS MENU	50
North OP Mode	50
Reference OP Mode.....	50
Reference Menu.....	50
Set Reference Heading	51
Reverse Reference Heading.....	51
Declination	51
Declination Menu.....	51
Set Declination	51
Calibration.....	51
COMPASS ALARMS	52
REFERENCE	53
PC INTERFACE	54
PC Requirements	54
CLEAR (RESET).....	54
CARE AND CLEANING	55
INSPECTIONS AND SERVICE.....	55
BATTERY REPLACEMENT.....	55
Data Retention	55
ALTITUDE SENSING AND ADJUSTMENT.....	56
TECHNICAL DATA	57
Z+ ALGORITHM NDL CHART.....	58
DSAT ALGORITHM NDL CHART	58
SPECIFICATIONS.....	59
INSPECTION/SERVICE RECORD	61
OCEANIC WORLD WIDE.....	61

NOTICES

LIMITED TWO-YEAR WARRANTY

For details, refer to the Product Warranty Registration Card provided. Register on-line at www.OceanicWorldwide.com

COPYRIGHT NOTICE

This operating manual is copyrighted, all rights are reserved. It may not, in whole or in part, be copied, photocopied, reproduced, translated, or reduced to any electronic medium or machine readable form without prior consent in writing from Oceanic/2002 Design.

OCS Operating Manual, Doc. No. 12-5272
© 2002 Design, 2011
San Leandro, CA USA 94577

TRADEMARK, TRADE NAME, AND SERVICE MARK NOTICE

Oceanic, the Oceanic logo type, OCS, the OCS logo, Diver Replaceable Batteries, Graphic Diver Interface, Tissue Loading Bar Graph (TLBG), Pre Dive Planning Sequence (PDPS), Set Point, Control Console, and OceanLog are all registered and unregistered trademarks, trade names, and service marks of Oceanic. All rights are reserved.

PATENT NOTICE

U.S. Patents have been issued, or applied for, to protect the following design features:

Data Sensing and Processing Device [U.S. Patent no. 4,882,678]. Set TLBG Alarm and other patents pending. User Settable Display [U.S. Patent no. 5,845,235] is owned by Suunto Oy (Finland).

DECOMPRESSION MODEL

The programs within the OCS simulate the absorption of nitrogen into the body by using a mathematical model. This model is merely a way to apply a limited set of data to a large range of experiences. The OCS dive computer model is based upon the latest research and experiments in decompression theory. **Still, using the OCS, just as using the U.S. Navy (or other) No Decompression Tables, is no guarantee of avoiding decompression sickness, i.e. "the bends."** Every diver's physiology is different, and can even vary from day to day. No machine can predict how your body will react to a particular dive profile.

Welcome
to
OCEANIC
and
THANK YOU
for choosing the
OCS

FEATURES AND FUNCTIONS

DISPLAY LAYOUT

ICONS

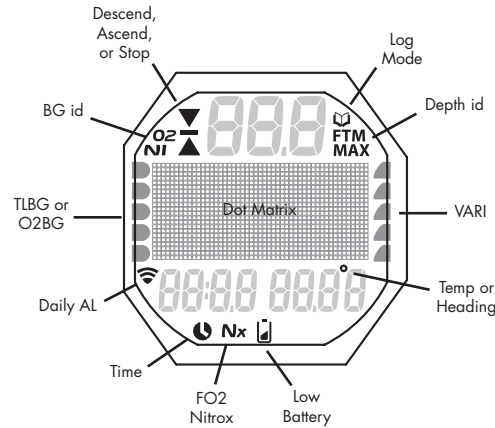

DISPLAY ABBREVIATIONS

ACTIV	= Activation	N	= North (compass)
AL	= Alarm	NDC	= No Deco DTR
ALT	= Alternate (watch time)	NDL	= No Deco Limit
AUD	= Audible	NE	= Northeast (compass)
AVAIL	= Available	NO	= Number
BATT	= Battery	NO-D	= No Decompression
CAL	= Calibrate (compass)	NORM	= Normal Dive Mode
CDT (CD)	= Countdown Timer	NW	= Northwest (compass)
CHRONO	= Chronograph (stop watch)	O2	= Oxygen
CONSERV	= Conservative Factor	OTR	= O2 DTR
DD	= Descending Depth (alarm)	PO2	= Partial Pressure of O2 (ATA)
DECO	= Decompression	REF	= Reference (compass)
DESAT	= Desaturation (nitrogen)	S	= South (compass)
DFLT	= Default	SAFE	= Safety (stop)
DSAT	= Algorithm type	SE	= Southeast (compass)
DTR	= Dive Time Remaining	SEC	= Seconds (time)
DURA	= Duration (backlight)	SET A	= Set Alarms
E	= East (compass)	SET F	= Set FO2 items
EDT	= Elapsed Dive Time	SET U	= Set Utilities
EL	= Elevation (altitude)	SN	= Serial Number
FO2	= Fraction of Oxygen (%)	SURF	= Surface
FORM	= Format (date, time)	SW	= Southwest (compass)
FREE	= Free Dive Mode	SWCH	= Switch (gas)
FT	= Feet (depth)	TAT	= Total Ascent Time (deco)
GAUG	= Digital Gauge Dive Mode	TLBG	= Tissue Loading Bar Graph
GLO	= Glow (backlight)	TMR	= Timer
HIST	= History	VIOL	= Violation
LO	= Low (battery)	W	= West (compass)
M	= Meters (depth)	Z+	= Algorithm type
MIN	= Minutes (time)		

INITIAL ACTIVATION

OCS Watch/Dive Computers are placed in a Deep Sleep mode prior to being shipped from the factory. The intent is to extend storage life of the Battery for up to 7 years, before the unit is initially placed in service.

In this mode, Date and Time are updated as they normally would be. However, they are not displayed. Upon waking the OCS up, the correct Date and USA Pacific Time will be displayed and it will be ready to operate with full functions.

To wake the OCS up from Deep Sleep mode, simultaneously depress the upper/right (S) and lower/left (A) buttons for 3 seconds until the display comes full ON displaying the Watch Main Time screen, then release them.

△ NOTE: Once the OCS is brought out of the Deep Sleep mode, it can only be placed back into it by the factory.

OVERVIEW

The OCS is a fully loaded Watch Dive Computer featuring >>

- 4 Control Buttons.
- 9 Menus.
- 30+ Set Selections.
- Increase/Decrease Set Values.
- 5 Operating Modes.
- 3 Nitrox Gas Mixes.
- 30+ Warnings/Alarms.
- Dual Watch Time.
- Dual Algorithm.
- Gas Switching.
- No Deco Deep Stop.
- No Deco Safety Stop.
- Gauge Depths to 660 FT/200 M.
- Gauge Dive Run Timer.
- Digital Compass.
- Altitude Compensation.
- NDL Conservative Factor.
- Variable Ascent Rate.
- PC Settings Upload/Data Download.
- Audible Alarm with flashing LED.
- User Replaceable Battery.
- User Upgradeable Firmware.

INTERACTIVE CONTROL CONSOLE

The Interactive Control Console utilizes 4 control buttons that allow you to maneuver through the OCS's unique system of menus.

The buttons will be referred to as M, S, L, and A.

- Upper/Left - Mode (M) button.
- Upper/Right - Select (S) button.
- Lower/Right - Light (L) button.
- Lower/Left - Advance (A) button.

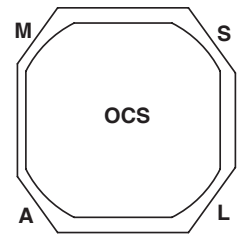

MENU SYSTEM

The Dot Matrix located in the middle of the LCD viewing area is used to display alpha numeric messages and measured values as well as Menu type systems for selection of settings and various auxiliary functions. It also serves as the Digital Compass which can be accessed during operation in any mode.

There are 10 Menus that include the -

- Watch Menu.
- Set Time Menu.
- NORM Menu.
- GAUG Menu.
- FREE Menu.
- Compass Menu.
- Set F Menu.
- Set A Menu.
- Set U Menu.

Each Menu has a Start (First) selection and a Stop (Last) selection. Upon entering a Menu, movement through it starts at the Start (First) selection, then continues in a rolling manner down the screen showing selections in groups of 3.

- The sample at the right shows how a menu would look if all of the selections would be displayed on one screen.

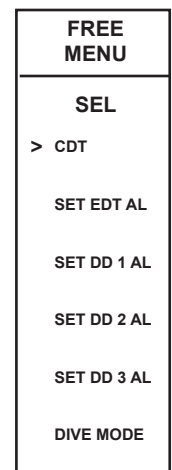

Sample Menu
(all selections shown)

Menu button action >>

- M (< 2 sec) - to access Menu.
- A (< 2 sec) - to step down the screen (forward) through selections.
- M (< 2 sec) - to step up the screen (backward) through selections.
- S (< 2 sec) - to access selection indicated by Arrow icon (>).

Right Arrow icon (>) at the left indicates the selection.

Down Arrow icon (v) at the right indicates that additional selections are available below (after) those shown.

Up Arrow icon (^) at the right indicates that additional selections are available above (before) those shown.

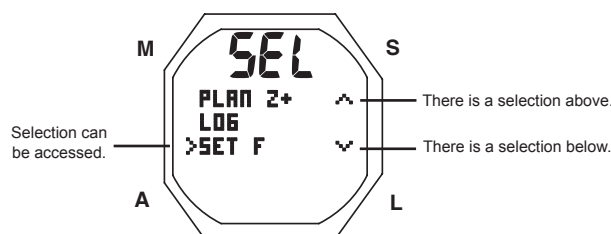

WATCH MODE STRUCTURE

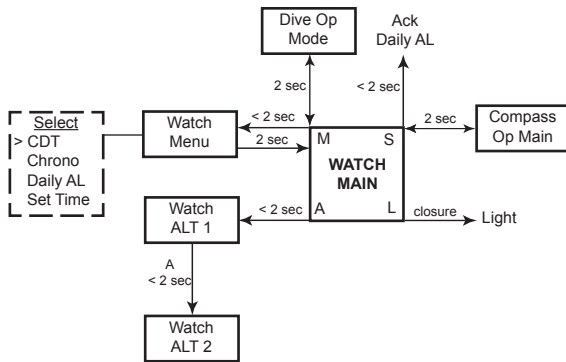

NORM SURFACE MODE STRUCTURE

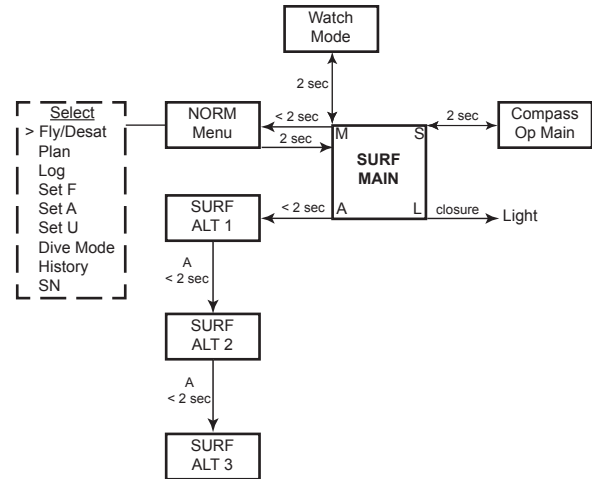

WATCH/NORM/GAUG SET MODE STRUCTURE

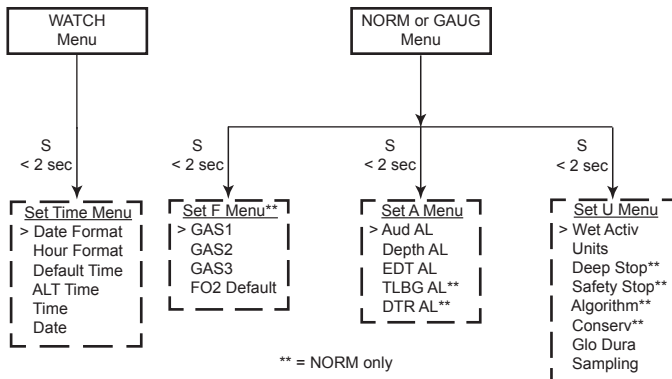

GAUG SURFACE MODE STRUCTURE

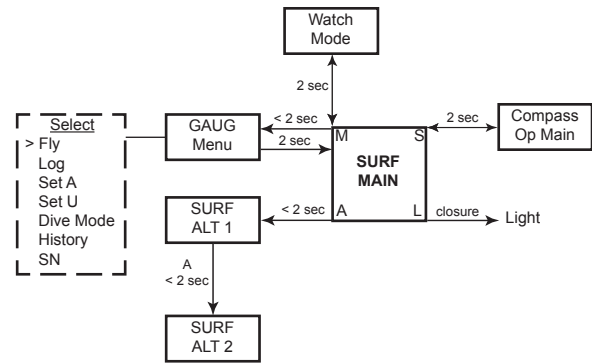

COMPASS MODE STRUCTURE SURFACE

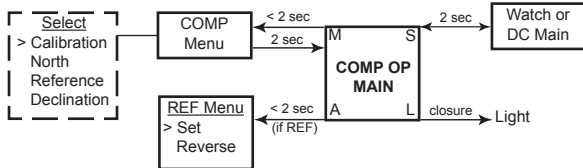

FREE SURF MODE STRUCTURE

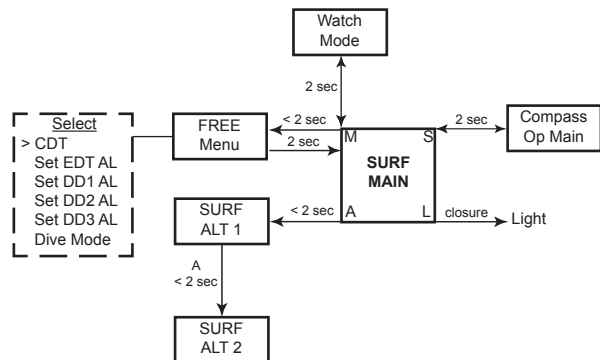

AUDIBLE ALARM

While operating in NORM or GAUG Mode the Audible will emit 1 beep per second for 10 seconds when alarms strike, unless it is set Off. During that time, the Audible can be acknowledged and silenced by pressing the S button (less than 2 seconds).

A LED Warning Light, on the lower end of the housing, is synchronized with the Audible and flashes as the Audible sounds. It will turn Off when the Alarm is silenced. The Audible and LED will not be active if the Audible is Set OFF (a group A setting).

FREE Dive Mode has its own set of Alarms which emit 3 short beeps either 1 or 3 times which cannot be acknowledged or set Off.

Situations that will activate the NORM/GAUG 10 second Alarm include -

** Items activate only in NORM mode.

- Descent deeper than the Depth Alarm Set Point selected.
- Dive Time Remaining at the Set Point selected**.
- Elapsed Dive Time at the Set Point selected.
- PO2 at the Set Point selected**.
- High O2 of 300 OTU (100%)**.
- TLBG at the Set Point selected**.
- Ascent Rate exceeds 60 FPM (18 MPM) when deeper than 60 FT (18 M), or 30 FPM (9 MPM) at 60 FT (18 M) and shallower.
- Entry into Decompression Mode (Deco)**.
- Conditional Violation (above a required Deco Stop Depth for less than 5 minutes)**.
- Delayed Violation (above a required Deco Stop Depth for more than 5 minutes)**.
- Delayed Violation (a Deco Stop Depth greater than 60 FT/18 M is required)**.
- Delayed Violation (Max Operating Depth of 330 FT/100 M is exceeded).
- A Gas Switch would expose the diver to PO2 => 1.60 ATA**.
- Watch Daily Alarm reaches time set (disabled during Dive Modes).
- Watch Mode Countdown Timer reaches 0:00.

A single short beep (which cannot be disabled) sounds when -

- After 5 minutes on the surface after the Violation dive.

3 short beeps (which cannot be disabled) sound when -

- Ascent Rate is 51 to 60 FPM (15.1 to 18 MPM) when deeper than 60 FT (18 M), or 26 to 30 FPM (7.5 to 9 MPM) at 60 FT (18 M) and shallower.
- FREE Dive Elapsed Dive Time Alarm (3 beeps every 30 seconds if set On).
- FREE Dive Depth Alarms 1, 2, 3 (set sequentially deeper) - each 3 beeps 3 times.
- FREE Dive TLBG Alarm (Caution zone, 4 segments) - 3 beeps 3 times.
- Entry into Deco during a FREE Dive (Violation) - 3 beeps 3 times.
- Free Dive Mode Countdown Timer reaches 0:00 - 3 beeps 3 times.

During the following NORM Dive situations, the 10 second tone will be followed by a 5 second beep that will not turn off when acknowledged -

- Ascent above a Deco Stop for more than 5 minutes.
- Deco requires a Stop Depth of 70 FT/21 M or deeper.
- On the Surface for 5 minutes after a Conditional Violation.

PC INTERFACE

Interface with a PC, to allow uploading settings and downloading data, is accomplished by connecting the OCS to a PC USB Port using the special OCS USB Interface Cable.

The software program together with the USB Driver required is on the Oceanlog CD, and can be downloaded from the OceanicWorldwide web site. The program's HELP** serves as the user manual which can be printed for personal use.

** Prior to attempting to Download data from your OCS or Upload Settings to it, review the HELP section of the Oceanlog program. Recommended is to print those sections of HELP that you consider appropriate for your Interface activities.

The Settings Upload portion of the Oceanlog program can be used to set/change the Main Time, Date, Set A group (Alarms), and Set U group (Utilities) using the same Interface System. FO2 and FREE Mode related items must be set using the control buttons.

Information available for retrieval (download) from the OCS to the PC Download portion of the program includes dive data such as number, surface interval time, maximum depth, elapsed dive time, no deco status, start date/time, lowest temperature under water, sampling rate, dive profile, and Set Points.

The Oceanlog program also allows upgrade of select versions of the OCS's firmware (operating system software) after which the OCS resets all operating data. Since the upgrades require reset of the OCS, they are blocked during 24 hours after dives.

- Refer to page 54 for more details relating to Oceanlog and PC Interface.

POWER SUPPLY

- Battery >> (1) 3 vdc, CR2450, Lithium battery.
- Shelf life >> up to 7 years (when shipped from factory in Deep Sleep mode).
- Use life >> 1 year or 300 dive hours if (2) 1 hour dives per dive day.
- Replacement >> user replaceable (annual recommended).

Battery icon:

- Warning >> icon on solid < 2.75 volts, battery change recommended.
- Alarm >> icon on flashing < 2.50 volts, change the battery.

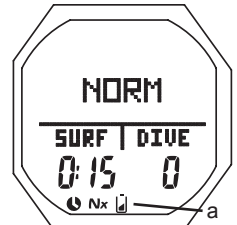

Fig. 1 - LOW BATT WARNING

LOW BATTERY WHILE ON THE SURFACE

<= 2.75 volts (warning level)

- Backlight is completely disabled.
- Battery icon (shell with inner bar) appears solid (Fig. 1 a).
- If a dive is started, the icon is not displayed on the dive mode screens.
- Watch and DC functions, including Compass Mode, continue to be available.

<=2.50 volts (Too Low - alarm level)

- All DC operations cease and the unit operates only as a Watch with Compass (view only).
- Low Battery icon (shell only with no inner bar) flashes for 5 seconds and operation reverts to Watch Time with Compass allowed (view only) until the Battery is changed or voltage cannot sustain operation, then the graphic CHANGE BATTERY flashes (Fig. 2) until the Battery is changed or voltage drops to the level at which operation cannot be maintained.

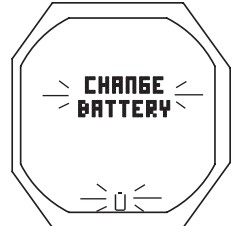

Fig. 2 - LOW BATT ALARM

LOW BATTERY DURING A DIVE

<= 2.75 volts (warning level)

- Backlight is completely disabled.
- Full DC functions and Compass continue to be available.
- Battery icon is not displayed on the dive mode screens.
- Battery icon (shell with inner bar) appears solid upon entry into Surface Mode.

<= 2.50 volts (Too Low - alarm level)

- Backlight is completely disabled.
- Full DC functions continue to be available during the dive.
- Battery icon is not displayed on the dive mode screens.
- Upon entry into Surface Mode, the Battery icon (shell only with no inner bar) and graphic CHANGE BATTERY flash for 5 seconds (Fig. 3) and operation reverts to Watch Time (Fig. 4), with Compass (view only) allowed, until the Battery is changed or voltage cannot sustain operation, then the graphic CHANGE BATTERY flashes until the Battery is changed or voltage drops to the level at which operation cannot be maintained.

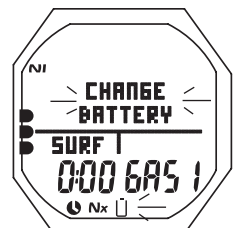

Fig. 3 - LOW BATT ALARM (after surfacing)



Fig. 4 - WATCH MODE (Low Batt Alarm)

WATCH MODE

WATCH MAIN (DEFAULT) TIME

Main (Default) Time is the Time that is displayed on the Watch until changed. It is also the Time viewed during operation in DC (Dive Computer) Modes.

Main Time is the current Time at your home location and is normally selected as the Watch Default Time.

Alternate Time, set by Hour Differential, is the current Time at a remote travel location. Upon arrival at the location, Alternate Time can be interchanged with Main Time to make it the Default Time while visiting the travel location.

Setting Time of Day and Alternate Time, and selection of the Default Time are functions in the Watch Set Time Menu.

Once Alternate Time is set, by Hour Differential, it will automatically change when Time of Day is set/changed. When Alternate Time is selected to be the Watch Default Time (while at a travel location), it will change directly when Time of Day is changed and Main (home) Time will then change by a differential opposite the one set for Alternate Time.

M (2 sec), or no button action during 2 minutes, while in any Watch sub routine, will revert to the Watch Default Time screen.

Main (Default) Time, information includes (Fig. 5):

- > Time of Day (hr:min:sec), Home (or Alternate if selected) with A or P if 12 hour format.
- > Graphic CDT with countdown time (hr:min), when set On.
- > Graphic ALT, if Alternate Time is selected as Default.
- > Day of Week graphic MON, TUE, WED, THU, FRI, SAT, or SUN.
- > Month.Day (or Day.Month).
- > Time (clock) icon.
- > Battery icon, if a Low Battery.
- > Alarm (speaker) icon, if Daily Alarm is set On.
- > TLBG, if any after NORM/FREE dives.

- A (< 2 sec) - to access Watch ALTs.
- M (< 2 sec) - to access Watch Menu.
- M (2 sec) - to access DC (Dive Computer) Mode.
- S (< 2 sec) - to silence Daily Alarm.
- S (2 sec) - to access Compass.
- L (press) - to activate Backlight.

Alt 1, information includes (Fig. 6):

- > Time of Day (hr:min:sec), Alternate (or Home if selected).
- > Graphic ALT, blank if Home Time is displayed.
- > Day of Week graphic MON, TUE, WED, THU, FRI, SAT, or SUN.
- > Month.Day (or Day.Month).
- > Battery icon, if a Low Battery.
- > Alarm (speaker) icon, if Daily Alarm is set On.
- > TLBG with NI icon, if any after NORM/FREE dives.

- A (< 2 sec) - to access ALT 2.
- 5 sec - reverts to Watch Default if A is not pressed.
- L (press) - to activate Backlight.

Alt 2, information includes (Fig. 7):

- > Altitude graphic EL2 (to EL 7), blank if Sea level.
- > Temperature with ° icon and graphic F (or C).

- 5 sec, or A (< 2 sec) - revert to Watch Default.
- L (press) - to activate Backlight.

WATCH MENU

- M (< 2 sec) - to access Menu, while viewing Default Time.
- A (< 2 sec) - to step down (forward) through selections.
- M (< 2 sec) - to step up (backward) through selections.
- S (< 2 sec) - to access selection indicated by Arrow icon (>).
- M or S (2 sec) - to revert to Default Time.

CDT (Countdown Timer) STATUS

Upon access, the following is displayed (Fig. 8/9) -

- > Graphics CD TMR solid with OFF (or ON) flashing.
- > Countdown Time (hr:min). If OFF, 0:00 or the CDT time if previously set. If ON, the remaining time (hr:min).

- A (< 2 sec) - to step through selections OFF, ON, and SET.
- S (< 2 sec) - to save the selection that is flashing.

- >> If OFF is selected, operation reverts to the Menu with no CDT displayed.
- >> If ON is selected, operation reverts to the Menu with the time set displayed and counting down.
- >> If SET is selected (Fig. 10), Set CD Timer is accessed.

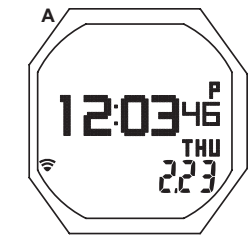

Fig. 5 - MAIN TIME

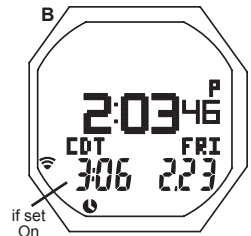

Fig. 6 - WATCH ALT 1

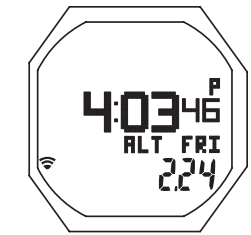

Fig. 7 - WATCH ALT 2

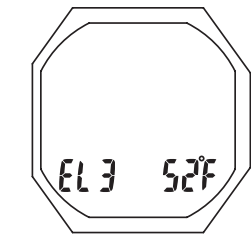

Fig. 8 - CDT STATUS (if Off upon access)

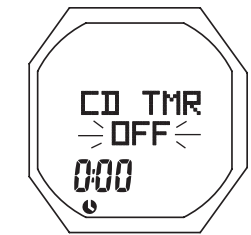

Fig. 9 - CDT STATUS (if On upon access)

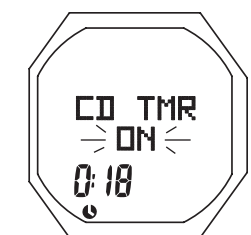
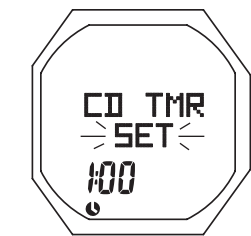

Fig. 10 - CDT STATUS (to access Set, or set/ready)



Set CDT, information includes (Fig. 11):

- > Graphics SET and CD TMR.
 - > CDT (hr:min) with Hour digits flashing.
 - > Time (clock) icon.
- A (hold) to scroll upward through Hour Set Points at a rate of 8 per second from 0: to 23: in increments of 1: (hr).
 - A (< 2 sec) - to step upward through Set Points one at a time.
 - M (< 2 sec) - to step back through Set Points one at a time.
 - S (< 2 sec) - to save the Hour Set Point and flash the Minute digits.
 - A (hold) - to scroll upward through Minute Set Points at a rate of 8 per second from :00 to :59 in increments of :01 (min).
 - A (< 2 sec) - to step upward through Set Points one at a time.
 - M (< 2 sec) - to step back through Set Points one at a time.
 - S (< 2 sec) - to save the CDT Set Point and revert to the CDT Status screen with SET flashing (similar to Fig. 10).
- A (< 2 sec) - to select OFF (to save for later use) or ON (to start the countdown).
 - S (< 2 sec) - to save the selection that is flashing.
- >> If OFF is selected, operation reverts to the Menu with no CDT displayed.
 >> If ON is selected, operation reverts to the Menu with the time set displayed and counting down.

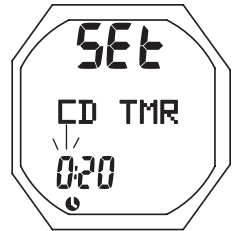

Fig. 11 - SET CDT

When a set Countdown Time reaches 0:00, the Audible Alarm will sound during which time the CDT digits on the Watch Default Time screen will be displayed as 0:00 flashing (Fig. 12).

FREE Dive Mode has a separate (min:sec) CDT.

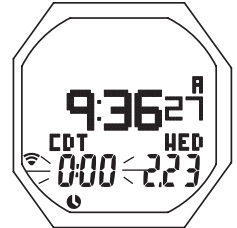

Fig. 12 - WATCH MAIN (during CDT Alarm)

CHRONOGRAPH (Stop Watch/Lap Timer)

Upon access from the Menu, the Status screen will be displayed.

Chrono Status, information includes (Fig. 13):

- > Graphic CHRONO.
 - > 0:00:00.00 (hr:min:sec .01 sec) if not running, or elapsed time with graphic LAP1 (or 2 to 9) if running.
 - > Time (clock) icon.
- S (< 2 sec) - to start Timer counting up from 0:00:00.00 to 9:59:59.99 max (hr:min:sec .01 sec) in increments of .01 (1/100th sec). After the first 4.99 seconds, the .01 digits display 2 dashes (- -).
 - S (< 2 sec) - to freeze Lap Times (1 up to 9), the Timer continues to run in the background.
 - A (< 2 sec) - to stop Timer and recall Laps (1 to 9), repeat to recall other Laps (Fig. 14).
 - A (2 sec) - to reset Timer to 0:00:00.00 and revert to the Chrono Status screen.



Fig. 13 - CHRONO (started, running)

While the Chronograph is running, it remains on the screen until another screen is accessed, it will then continue to run in the background while on the surface. Upon descending on a dive, Chrono operation will be terminated and reset to 0:00:00.00.



Fig. 14 - CHRONO (started, frozen or recalled)

DAILY ALARM

When set On, the Daily Alarm will -

- > be synchronized with the Watch Default Time selected.
- > sound the Audible at the Time set every day.
- > not sound the Audible while operating in DC Modes.
- > run in the background until set Off.

Daily Alarm Status

Upon access, the following is displayed (Fig. 15) -

- > Graphics DAILY AL solid, with OFF (or ON) flashing.
 - > Alarm Time (hr:min) set with graphic A (or P) if 12 Hour Format and Time (clock) icon.
- A (< 2 sec) - to step through selections OFF, ON, and SET.
 - S (< 2 sec) - to save the selection that is flashing.



Fig. 15 - DAILY ALARM STATUS (upon access)

- >> If OFF is selected, operation reverts to the Menu.
- >> If ON is selected, operation reverts to the Menu with the Alarm enabled.
- >> If SET is selected (Fig. 16), Set Daily Alarm is accessed.

Set Daily Alarm, information includes (Fig. 17):

- > Graphics SET and DAILY AL.
 - > Alarm Time (hr:min) with Hour digits flashing with Time (clock) icon.
- A (hold) - to scroll upward through Hour Set Points at a rate of 8 per second from 0: to 23: in increments of 1: (hr).
 - A (< 2 sec) - to step upward through Set Points one at a time.
 - M (< 2 sec) - to step back through Set Points one at a time.
 - S (< 2 sec) - to save the Hour Set Point and flash the Minute digits.
 - A (hold) - to scroll upward through Minute Set Points at a rate of 8 per second from :00 to :59 in increments of :01 (min).
 - A (< 2 sec) - to step upward through Set Points one at a time.
 - M (< 2 sec) - to step back through Set Points one at a time.
 - S (< 2 sec) - to save the Set Point and revert to the Daily Alarm Status screen with SET flashing (similar to Fig. 16).



Fig. 16 - DAILY AL STATUS (to access Set or set/ready)

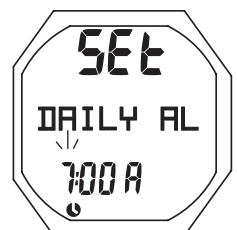

Fig. 17 - SET ALARM TIME

SET TIME MENU

- S (< 2 sec) - to access Set Time Menu, while the selection Arrow icon (>) is next to Set Time on the Watch Menu.
- A (< 2 sec) - to step down (forward) through selections.
- M (< 2 sec) - to step up (back) through selections.
- S (< 2 sec) - to access a Time Menu selection indicated by Arrow icon (>).

Set Date Format, information includes (Fig. 18):

Date Format establishes the position that the Month (M) digits are displayed relative to the Day (D) digits, on the left or right.

- > Graphic DATE FORMAT.
- > Set Point graphics MNTH.DAY and DAY.MNTH; Arrow (>) icon next to the one previously saved flashing.

- A (< 2 sec) - to toggle Set Points.
- S (< 2 sec) - to save Set Point and revert to Set Time Menu.

Set Hour Format, information includes (Fig. 19):

- > Graphic HOUR FORMAT.
- > Set Point graphics 12 and 24; Arrow (>) icon next to the one previously saved flashing.

- A (< 2 sec) - to toggle Set Points.
- S (< 2 sec) - to save Set Point and revert to Set Time Menu.

Select Default Time, information includes (Fig. 20):

This feature selects whether Main (home) Time or Alternate (travel location) Time will be displayed as the Watch Default Time. The other will be displayed on the Watch ALT 1 screen.

- > Graphics SEL and DFLT TIME solid.
- > Set Point graphics MAIN (home) and ALT (travel location, by Differential set); Arrow (>) icon next to the one previously saved flashing.

- A (< 2 sec) - to toggle Set Points.
- S (< 2 sec) - to save Set Point and revert to Set Time Menu.

Set Alternate Time, information includes (Fig. 21):

This feature sets an Hour based numeric time Differential ranging from - 23 through 0 to + 23 (hours).

Once the Differential is selected/saved, Alternate Time/Date values are based on the Time of Day Set Points unless changed while at a travel location with ALT Time selected as the Watch Default Time in which case Main (home) Time would change by a differential opposite to the one previously set for ALT Time.

- > Graphics SET and ALT TIME solid.
- > Set Point graphic OFF, or the +/- numeric Hour Differential with graphic HR, all flashing.

- A (hold) - to scroll upward through Set Points at a rate of 8 per second from - 23 through 0 to + 23 in increments of 1.
- A (< 2 sec) - to step upward through Set Points one at a time.
- M (< 2 sec) - to step back through Set Points one at a time.
- S (< 2 sec) - to save the Differential Set Point and revert to the Set Time Menu.

Set Time of Day, information includes (Fig. 22):

This setting directly changes the Time of Day that is selected to be the Watch Default Time, whether it is Main (home) Time or Alternate (travel location) Time. The other will be changed by the Time Differential set.

- > Graphic TIME.
- > Time of Day (hr:min), Hour digits flashing, with graphic A (or P) if 12 Hour Format.
- > Graphic ALT, if Alternate is Default Time (at travel location).

- A (hold) - to scroll upward through Hour Set Points at a rate of 8 per second from 12: A to 11: P, or 0: to 23: if 24 Hour Format, in increments of 1: (hr).
- A (< 2 sec) - to step upward through Set Points one at a time.
- M (< 2 sec) - to step back through Set Points one at a time.
- S (< 2 sec) - to save the Hour Set Point and flash the Minute digits.
- A (hold) - to scroll upward through Minute Set Points at a rate of 8 per second from :00 to :59 in increments of :01 (min).
- A (< 2 sec) - to step upward through Set Points one at a time.
- M (< 2 sec) - to step back through Set Points one at a time.
- S (< 2 sec) - to save the Time Set Point and revert to the Set Time Menu.

Set Date, information includes (Fig. 23):

The sequence for setting date is Year, then Month, then Day, regardless of the Date Format set.

- > Graphic DATE.
- > Graphics YEAR MNTH.DAY (or (DAY.MNTH)).
- > Date with Year digits flashing.

- A (hold) - to scroll upward through Year Set Points at a rate of 8 per second from 2008 to 2051, in increments of 1
- A (< 2 sec) - to step upward through Set Points one at a time

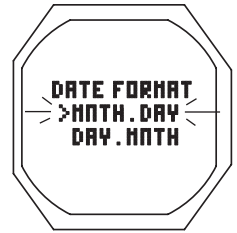

Fig. 18 - SET DATE FORMAT

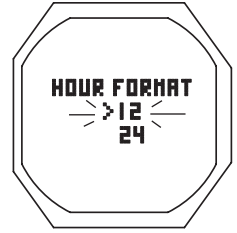

Fig. 19 - SET HOUR FORMAT



Fig. 20 - SET DEFAULT TIME

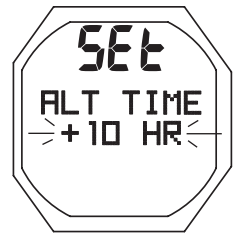

Fig. 21 - SET ALTERNATE TIME

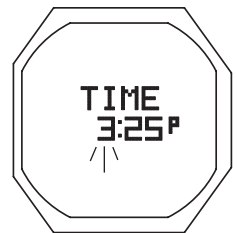

Fig. 22 - SET TIME

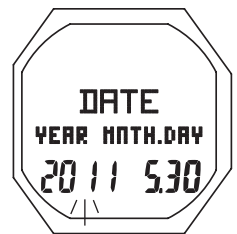
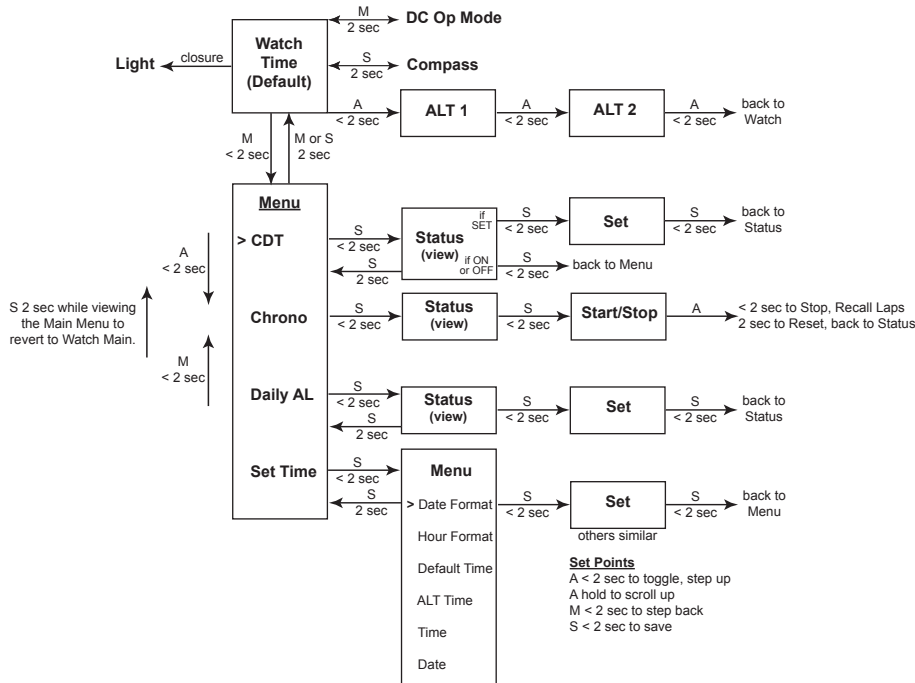

Fig. 23 - SET DATE

Day of the week is set automatically based on the Date set.

- M (< 2 sec) - to step back through Set Points one at a time
- S (< 2 sec) - to save the Year Set Point and flash the Month digits
- A (hold) - to scroll upward through Month Set Points at a rate of 8 per second from 1 to 12 in increments of 1
- A (< 2 sec) - to step upward through Set Points one at a time
- M (< 2 sec) - to step back through Set Points one at a time
- S (< 2 sec) - to save the Month Set Point and flash the Day digits
- A (hold) - to scroll upward through Day Set Points at a rate of 8 per second from 1 to 31 (max) in increments of 1
- A (< 2 sec) - to step upward through Set Points one at a time
- M (< 2 sec) - to step back through Set Points one at a time
- S (< 2 sec) - to save the Date Set Point and revert to the Set Time Menu.

**SUMMARY OF
WATCH MODE OPERATIONS**



NORM

SURFACE MODES

NORM SURFACE FUNCTIONS

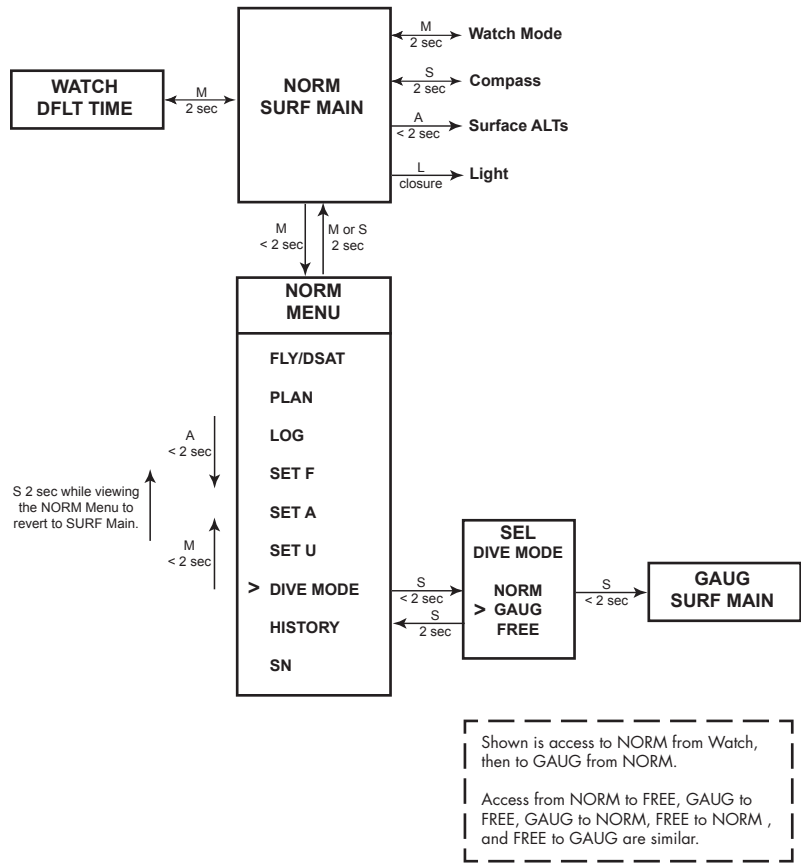

DIVE COMPUTER OPERATING MODES

- NORM Mode >> for Air and Nitrox SCUBA activity with up to 3 Gases.
- GAUG Mode >> for SCUBA activity with Depth/Time indication.
- FREE Mode >> for breath hold diving activity with Depth/Time indication.

If no previous dive has been taken within the past 24 hours, NORM is the default upon access from Watch Time. Others accessed as indicated above.

At any time while operating in Surface Modes, operation will enter the Dive Mode selected upon descent to 5 FT (1.5 M) for 5 seconds.

- When Wet Activation is set OFF, Dive Mode will only be activated during operation in a DC Mode. It will not activate while in Watch Mode.
- When Wet Activation is set ON, the selected Dive Mode will activate upon descent regardless of what mode it is operating in at the time.

Post Dive:

Operation will revert from Dive Mode to Post Dive Surface Mode upon ascent to 2 FT (0.6 M) for 1 second.

During the first 10 minutes on the surface after a NORM/GAUG dive, or 1 minute after a FREE dive >>

- The Dive Main will be displayed with Surface Interval time and access to Dive ALT screens.
- A descent during the first 10 minutes after surfacing from a NORM or GAUG dive, or the first 1 minute after surfacing from a FREE dive, is a continuation of that dive.

After the 10 minute (or 1 minute) interval on the surface has elapsed >>

- The Surface Main will be displayed with accessed given to other surface displays.
- A descent is then considered a new dive.

NORM SURF MAIN, information includes (Fig. 24/25):

- > Graphic NORM.
- > Graphic SURF and SI (hr:min) with Time (clock) icon; if no dive yet, this is time since access to NORM.
- > Graphic DIVE and number of dives completed during that operating period, up to 24 (0 if no dive made yet).
- > Nx icon, if any Gas is set for Nitrox.
- > TLBG with NI icon, if any after a NORM or FREE dive.
- > Battery icon, if voltage is low.

- A (< 2 sec) - to access ALT 1.
- M (< 2 sec) - to access NORM Menu.
- M (2 sec) - to access Watch Main.
- S (2 sec) - to access Compass OP Main**.
- L (press) - to activate Backlight.

** Compass can only be accessed from Main.

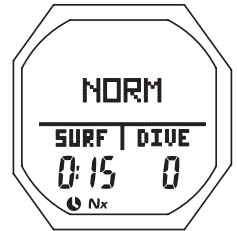

Fig. 24 - NORM SURF MAIN (no dive yet)

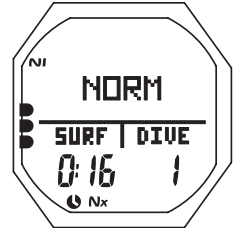

Fig. 25 - NORM SURF MAIN (after dive 1)

NORM SURF ALT 1 (Last), information includes (Fig. 26):

- > Max Depth with MAX and FT (or M) icons, 2 dashes (--) if no previous dive.
- > Elapsed Dive Time (hr:min) with graphic EDT, 3 dashes (-:-) if no previous dive.
- > Graphic LAST DIVE, indicating that data is from the dive previously conducted while in NORM mode.

- A (< 2 sec) - to access ALT 2.
- 10 sec - revert to Main, if A is not pressed.
- L (press) - to activate Backlight.

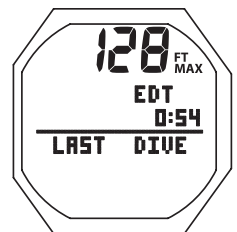

Fig. 26 - NORM SURF ALT 1 (Last dive's data)

NORM SURF ALT 2, information includes (Fig. 27):

- > Time of Day (hr: min sec) with A (or P).
- > Altitude graphic, if EL2 (to EL7), blank if Sea level.
- > Temperature with ° icon and graphic F (or C).

- A (< 2 sec) - to access ALT 3 (if set for Nitrox), or revert to Main (if set for Air).
- 5 sec - revert to Main, if A is not pressed.
- L (press) - to activate Backlight.



Fig. 27 - NORM SURF ALT 2

NORM SURF ALT 3, information includes (Fig. 28):

- > Graphic O2.
- > Graphics FO2 and GAS 1 with FO2 Set Point.
- > Nx icon.
- > O2BG with O2 icon, if any after a dive.

- 5 sec or A (< 2 sec) - to revert to Main.
- L (press) - to activate Backlight.

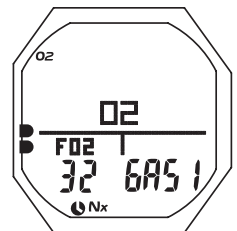

Fig. 28 - NORM SURF ALT 3

NORM MENU

- M (< 2 sec) - to access Menu, while viewing Surface Main.
- A (< 2 sec) - to step down (forward) through selections.
- M (< 2 sec) - to step up (backward) through selections.
- S (< 2 sec) - to access selection indicated by Arrow icon (>).
- M (2 sec) any time - to revert to Surface Main.
- S (2 sec), while viewing the menu - to revert to Surface Main.
- 2 min (no button action) - will revert to Surface Main.

FLY/DESAT TIME

Fly Time is a count down timer that begins counting down 10 minutes after surfacing from a dive from 23:50 to 0:00 (hr:min).

Desat Time (Desaturation of Nitrogen), also a count down timer, provides calculated time for tissue desaturation at sea level taking into consideration the Conservation Factor setting.

Desat Time also begins counting down 10 minutes after surfacing from a dive, counting down from 23:50 (max) to 0:00 (hr:min).

When the Desat count down reaches 0:00, which will generally occur prior to the Fly count down reaching 0:00, it will remain on the display as 0:00 until the Fly count down reaches 0:00.

- > Desat is not displayed after a Gauge or Violation dive.
- > Desaturation requiring Times greater than 24 hours will display 23:--.
- > In the event that Time to Desaturate still remains at the end of 24 hours, the added time will be zeroed.
- > When other screens are accessed, the Fly and Desat countdowns continue in the background.

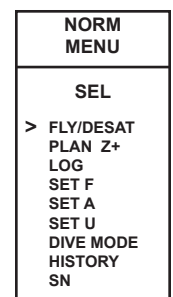

Fly/Desat, information includes (Fig. 29/30):

- > Time to Fly (hr:min), 0:00 if no dive yet, dashes (- : -) during first 10 min on surface, with graphic FLY.
 - > Time to Desat (hr:min), 0:00 if no dive yet, dashes (- : -) during first 10 min on surface, with graphic DESAT.
 - > Time (clock) icon.
- S (< 2 sec) - to revert to Menu.
 - L (press) - to activate Backlight.



Fig. 29 - FLY/DESAT (10 min after dive)

NORM PLAN MODE

No Deco Dive Times (NDLs) in NORM Plan Mode are based on the Algorithm selected (DSAT or Z+) and only on the FO2 set for Gas 1. FO2 set for Gas 2 and 3 are not used.

NORM Menu >> Plan Lead-in >> PDPS

Plan Lead-in, information includes (Fig. 31A/B):

- > Graphic PLAN.
 - > Graphic FO2_1 (Gas 1).
 - > Graphic Air or numeric % value (21 to 100), indicating the FO2 set for Gas 1.
 - > Graphic PO2 with PO2 Alarm value set (1.20 to 1.60), if Nitrox, blank if Air.
 - > Nx icon, if Nitrox.
- S (< 2 sec) - to access PDPS.
 - L (press) - to activate Backlight.



Fig. 30 - FLY/DESAT (< 10 min after dive)

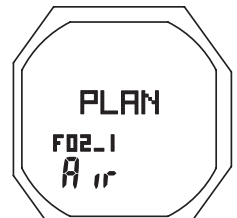

Fig. 31A - PLAN LEAD-IN (Gas 1 set for Air)

PDPS (Pre Dive Planning Sequence)

The PDPS displays Depths and allowable No Deco Dive Times. It will sequence through Depths from 30 to 190 FT (9 to 57 M), or the Max Depth that will allow theoretical No Deco Dive Time of at least 1 minute based upon the previous dive profiles in a series of repetitive dives and taking into account descent and ascent rates of 60 FPM (18 MPM).

When the Conservative Factor is set On, No Deco Dive times are reduced to the values of the next 3000 foot (915 meter) higher Altitude. Refer to tables in back.

PDPS, information includes (Fig. 32A/B):

- > Max Depth with MAX and FT (or M) icons, if Nitrox, blank if set for Air.
- > Plan Depth value with graphic FT (or M).
- > Graphic NDC (or OTR) with Dive Time allowed (hr:min) with Time (clock) icon, no OTR if Air.
- > Graphic PO2 with PO2 Alarm value set for Gas 1 (1.20 to 1.60), if Nitrox, blank if set for Air.
- > Nx icon, if Nitrox.

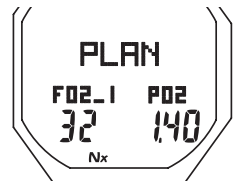

Fig. 31B - PLAN LEAD-IN (Gas 1 set for Nitrox)

- A (hold) to scroll upward through screens at a rate of 8 per second increasing planned Depth from 30 to 190 FT (9 to 57 M) in increments of 10 FT (3 M).
- A (< 2 sec) - to step upward through screens one at a time.
- M (< 2 sec) - to step back through screens one at a time.
- S (< 2 sec) - to revert to the Plan Lead-in screen.
- L (press) - to activate Backlight.

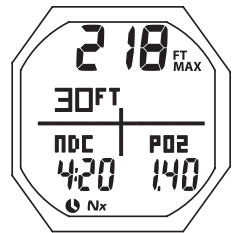

Fig. 32A - PDPS (nitrogen control)

NORM/GAUG LOG MODE

Information from the latest 24 NORM and/or GAUG dives is stored for viewing. After exceeding 24 dives, the most recent dive is stored while the oldest is deleted.

- > Dives are numbered from 1 to 24 starting each time NORM (or GAUG) Dive Mode is activated. After the post dive 24 hour period has elapsed, the first dive of the next operation period is #1.
- > 10 minutes after surfacing from dives, the Log screens for that dive as well as all other dives stored can be viewed.
- > In the event that a dive's elapsed time (EDT) exceeds 9:59 (hr:min), the data at the 9:59 interval is recorded in the Log upon surfacing of the unit.

NORM Menu >> Log Preview >> Log Data 1 >> Log Data 2

Log Preview, information includes (Fig. 33):

- > Log Mode (book) icon.
 - > Graphic NO-D (or DECO or VIOL).
 - > Graphic DIVE and dive number (1 to 24, 0 if no dive yet).
 - > Time dive began (hr:min) with Time (clock) icon and A (or P), and the graphic ALT if Alternate Time.
 - > Date, the dive was conducted.
 - > Nx icon, if Nitrox.
- A (hold) - to scroll upward through Preview screens at a rate of 8 per second.
 - A (< 2 sec) - to step upward through screens one at a time.
 - M (< 2 sec) - to step back through screens one at a time.
 - S (< 2 sec) - to access that dive's Log Data 1 screen.
 - L (press) - to activate Backlight.



Fig. 32B - PDPS (oxygen control)

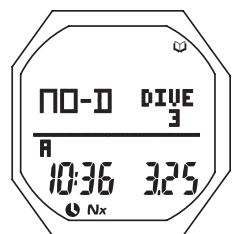

Fig. 33 - LOG PREVIEW

Log Data 1, information includes (Fig. 34):

- > Log Mode (book) icon.
- > Max Depth with MAX and FT (or M) icons.
- > Graphic DSAT (or Z+), the Algorithm selected.
- > Graphic EDT with Dive Time (hr:min).
- > Graphic SURF and pre dive SI (hr:min), 0:00 if Dive # 1, 9: -- if > 9:59, with Time (clock) icon.
- > Temperature (minimum that dive) with ° icon and graphic F (or C).
- > TLBG with the max segment flashing, others fixed up to end of dive accumulation. All segments flashing if a Violation. Blank if GAUG.
- > VARI, max Ascent Rate sustained for 4 sec.
- > Nx icon, if Nitrox.

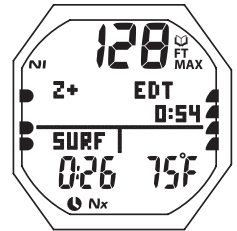

Fig. 34 - LOG DATA 1

- S (< 2 sec) - to access the dive's Log Data 2 screen if Nitrox, or revert to the Preview screen if Air or a Violation.
- L (press) - to activate Backlight.

Log Data 2 (Nitrox only), information includes (Fig. 35):

- > Log Mode (book) icon.
- > Graphic GAS 1 (or 2 or 3), in use when dive ended.
- > Graphic FO2 with FO2 Set Point (or graphic Air) for Gas in used when dive ended.
- > Graphic PO2 with value of Max PO2 achieved.
- > Nx icon.
- > O2BG with O2 icon, accumulated when dive ended.



Fig. 35 - LOG DATA 2

- S (< 2 sec) - to revert to the Preview screen.
- L (press) - to activate Backlight.

SET F (FO2)

Each Gas has an individual FO2 and an associated PO2 Alarm setting.

Default settings are FO2 Air with no PO2 value for Gas 1, and Off for Gas 2 & 3. Settings revert to the defaults when 24 hours elapse without conducting a dive.

When FO2 is set for Air -

- > calculations are the same as when FO2 is set for 21%.
- > it remains set for Air until set for Nitrox (21 to 100%).
- > O2 data (such as PO2, O2%) will not be displayed at any time during the dive, on the surface, or in Plan mode.
- > MODs (Max Operating Depths) will not be displayed on the FO2 set screen.
- > internally, it will keep track of O2 data for use if FO2 is subsequently set for Nitrox for repetitive dives.

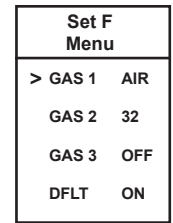

Fig. 36 - SET F MENU

When FO2 is set for Nitrox -

- > The Air option will not be displayed as an FO2 setting until 24 hours elapse after the last dive.

When FO2 is set for OFF (Gas 2, 3) -

- > That Gas will not be available in the Gas Switch routine during dives (no Switch To - screen).

FO2 50% Default -

- > When the Default is set OFF, FO2 values will remain set at their last settings saved until 24 hours elapse without conducting a dive.
- > When the Default is set ON and FO2 is set for Nitrox, 10 minutes on the surface after that dive the FO2 will be displayed as 50 and further dives will be calculated based on 50% O2 for oxygen calculations and 21% O2 for Nitrogen calculations (79% Nitrogen), unless FO2 is set before the dive.
- > FO2 will continue to reset to the Default after repetitive dives until 24 hours elapse with no dive, or the Default is set OFF.



Fig. 37A - SET GAS 1 FO2 (default)

SET F (FO2) MENU

Menu selections (Fig. 36) >> Gas 1 >> Gas 2 >> Gas 3 >> FO2 Default.

- S (< 2 sec) - to access Set F Menu while the selection Arrow icon (>) is next to Set F on the NORM Menu.
- A (< 2 sec) - to step down (forward) through selections.
- M (< 2 sec) - to step up (back) through selections.
- S (< 2 sec) - to access selection indicated by Arrow icon (>).

The last setting saved, or the default, is displayed next to each Menu item.

SET GAS 1 FO2/PO2, information includes:

- > Max Depth allowed for the PO2 Alarm setting displayed, blank when Air.
- > Graphic GAS1.
- > Graphic FO2 with setting Air or 21 to 100 flashing (Fig. 37A/B).
- > Graphic PO2 with Alarm value set.
- > Nx icon (if Nitrox, numerical values), blank if Air.

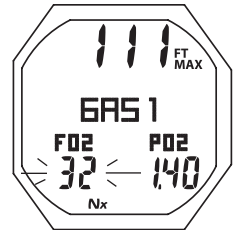

Fig. 37B - SET GAS 1 FO2 (Nitrox)

- A (press/hold), while the FO2 digits are flashing - to scroll upward through the Set Points from Air to 21 through 100 in 1% increments, at a rate of 8 per second.
 - >> *The scroll will stop when the button is released, or momentarily at 32, then 50, then 80 (%).*

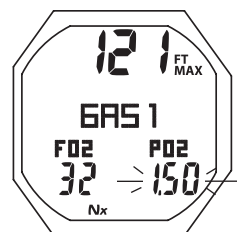

Fig. 38 - SET GAS 1 PO2 ALARM

- A (< 2 sec) - to step upward through FO2 Set Points.
 - M (< 2 sec) - to step back through FO2 Set Points.
 - S (< 2 sec) - save the FO2 setting and flash the PO2 digits (Fig. 38, page 20), or revert to SURF MAIN if Air.
-
- A (< 2 sec) - to step upward through PO2 Alarm Set Points from 1.20 to 1.60 (ATA) in .05 increments.
 - M (< 2 sec) - to step back through PO2 Set Points.
 - S (< 2 sec) - to save the PO2 setting and access Set Gas 2.
 - S (2 sec) - to revert to Set F displaying the settings.
 - M (2 sec) - to revert to SURF MAIN, or if no button is pressed during a 2 minute period.

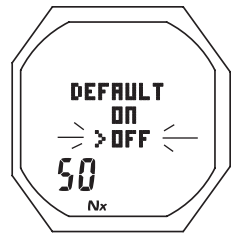

Fig. 39 - SET FO2 DEFAULT

SET GAS 2 FO2/PO2, information includes:

- > Max Depth allowed for the PO2 Alarm setting displayed, blank when Air.
- > Graphic GAS2.
- > Graphic FO2 with setting OFF, Air, or 21 to 100 flashing (Fig. 37A/B, page 20).
- > Graphic PO2 with Alarm value set, blank if OFF or Air.
- > Nx icon (if Nitrox, numerical values), blank if OFF or Air.

- A (press/hold), while the FO2 digits are flashing - to scroll upward through the Set Points from Air to 21 through 100 in 1% increments, at a rate of 8 per sec.
 - >> *The scroll will stop when the button is released, or momentarily at 32, then 50, then 80 (%).*
 - A (< 2 sec) - to step upward through FO2 Set Points.
 - M (< 2 sec) - to step back through FO2 Set Points.
 - S (< 2 sec) - to save the FO2 setting and flash the PO2 digits (Fig. 38, page 20), or revert to SURF MAIN if Air.
-
- A (< 2 sec) - to step upward through PO2 Alarm Set Points from 1.20 to 1.60 (ATA) in 0.05 increments.
 - M (< 2 sec) - to step back through PO2 Set Points.
 - S (< 2 sec) - to save the FO2 setting and access Set Gas 3.
 - S (2 sec) - to revert to Set F displaying the settings.
 - M (2 sec) - to revert to SURF MAIN, or if no button is pressed during a 2 minute period.

SET GAS 3 FO2/PO2 is similar to SET GAS 2.

Once any Gas is set for Nitrox, any other Gas set for Air will automatically be set to 21%.

SET FO2 50% DEFAULT, information includes (Fig. 39):

- > Graphics DEFAULT and 50.
- > Set Point graphic OFF (or ON), flashing.
- > Nx icon.

- S (< 2 sec) - to toggle between OFF and ON.
- A (< 2 sec) - to save the setting and revert to Set F.

SET A (ALARMS) MENU

S (< 2 sec) - to access Set A Menu while the selection Arrow icon (>) is next to Set A on the NORM (or GAUG) Menu.

- A (< 2 sec) - to step down (forward) through selections.
- M (< 2 sec) - to step up (back) through selections.
- S (< 2 sec) - to access selection indicated by Arrow icon (>).

Set Audible Alarm, information includes (Fig. 40):

- > Graphic AUDIBLE.
- > Set Point graphics ON and OFF; Arrow (>) icon next to the one previously saved flashing.

- A (< 2 sec) - to toggle Set Points.
- S (< 2 sec) - to save the setting and revert to the Set A Menu.

Set Depth Alarm, information includes (Fig. 41):

- > Graphic DEPTH AL.
- > Graphic OFF flashing, or Depth value flashing with FT (or M) and MAX icons.

- A (hold) - to scroll upward through Set Points at a rate of 8 per sec from 30 to 330 FT (10 to 100 M) in increments of 10 FT (1 M).
- A (< 2 sec) - to step upward through Set Points one at a time.
- M (< 2 sec) - to step back through Set Points one at a time.
- S (< 2 sec) - to save the setting and revert to the Set A Menu.

There is a separate alarm associated with exceeding the MOD (max operating depth) which is a violation described later. FREE mode has separate Depth Alarms that are not affected by this setting.

Set EDT Alarm, information includes (Fig. 42):

- > Graphic EDT AL
- > Elapsed Dive Time value (hr:min) flashing with MAX and Time (clock) icons

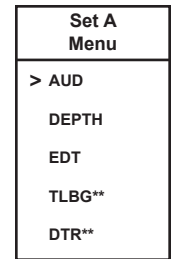

** NORM only

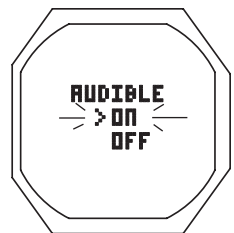

Fig. 40 - SET AUDIBLE AL

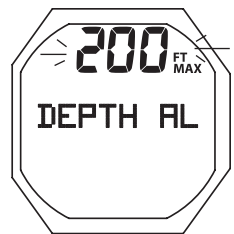

Fig. 41 - SET DEPTH AL



Fig. 42 - SET EDT AL



Fig. 43 - SET TLBG AL



Fig. 44 - SET DTR AL

- A (hold) - to scroll upward through Set Points at a rate of 8 per sec from 0:10 to 3:00 (hr:min) in increments of 0:05 (:min).
- A (< 2 sec) - to step upward through Set Points one at a time.
- M (< 2 sec) - to step back through Set Points one at a time.
- S (< 2 sec) - to save the setting and revert to the Set A Menu.

FREE Mode has a separate EDT Alarm.

Set TLBG Alarm, information includes (Fig. 43, page 21):

- > Graphic TLBG AL.
- > Depth value flashing with MAX and FT (or M) icons.

- A (< 2 sec) - to step upward through Set Points from 1 to 4 segments one at a time.
- M (< 2 sec) - to step back through Set Points one at a time.
- S (< 2 sec) - to save the setting and revert to the Set A Menu.

FREE Mode has a separate TLBG Alarm.

Set DTR Alarm, information includes (Fig. 44, page 21):

- > Graphic DTR AL.
- > Dive Time Remaining value (hr:min) flashing with Time (clock) icon.

- A (hold) to scroll upward through Set Points at a rate of 8 per sec from 0:00 to 0:20 (hr:min) in increments of 0:01 (:min).
- A (< 2 sec) - to step upward through Set Points one at a time.
- M (< 2 sec) - to step back through Set Points one at a time.
- S (< 2 sec) - to save the setting and revert to the Set A Menu.

SET U (UTILITIES) MENU

- S (< 2 sec) - to access Set U Menu while the selection Arrow icon (>) is next to Set U on the NORM (or GAUG) Menu.
- A (< 2 sec) - to step down (forward) through selections.
- M (< 2 sec) - to step up (back) through selections.
- S (< 2 sec) - to access selection indicated by Arrow icon (>).

Selections for Wet Activation, Units, Algorithm, Conservative Factor, and Glo Duration also apply to FREE Dive Mode.

- > To change any of these items while in FREE mode, use the Set U selection in the NORM Menu.

Set Wet Activation, information includes (Fig. 45):

- > Graphic WET ACTIV.
- > Set Point graphics ON and OFF, Arrow (>) icon next to the one previously saved flashing.

- A (< 2 sec) - to toggle Set Points.
- S (< 2 sec) - to save the setting and revert to the Set U Menu.

Set Units, information includes (Fig. 46):

- > Graphic UNITS.
- > Set Point graphics IMPERIAL and METRIC, Arrow (>) icon next to the one previously saved flashing.

- A (< 2 sec) - to toggle Set Points.
- S (< 2 sec) - to save the setting and revert to the Set U Menu.

Set Deep Stop, information includes (Fig. 47):

- > Graphic DEEP STOP.
- > Set Point graphics ON and OFF, Arrow (>) icon next to the one previously saved flashing.

- A (< 2 sec) - to toggle Set Points.
- S (< 2 sec) - to save the setting and revert to the Set U Menu.

Deep Stop applies only to NORM No Deco dives.

Set Safety Stop, information includes (Fig. 48A):

- > Graphics SS (= Safety Stop).
- > Set Point graphics OFF, ON, TMR ON; Arrow (>) icon next to ON or OFF, the one previously saved, flashing.

- A (< 2 sec) - to step forward through Set Points one at a time.
- M (< 2 sec) - to step back through Set Points one at a time.
- S (< 2 sec) - to save the setting.

- > If OFF or TMR ON is selected/saved, operation will revert to the Set U Menu.
- > If ON is selected/saved, the Set Stop Time/Depth screen is displayed with the Time digits flashing (Fig. 48B).

- A or M (< 2 sec) - to toggle between 3:00 and 5:00 (min:sec).
- S (< 2 sec) - to save the Time setting and flash the Depth digits.
- A (< 2 sec) to step forward through Depth Set Points of 10, 15, 20 FT (or 3, 4, 5, 6 M).
- M (< 2 sec) to step back through Set Points one at a time.
- S (< 2 sec) to save the SS Time/Depth setting and revert to the Set U Menu.

Safety Stop applies only to NORM No Deco dives.

Set Algorithm, information includes (Fig. 49):

- > Graphic ALGORITHM.
- > Set Point graphics Z+ and DSAT, Arrow (>) icon next to the one previously saved flashing.

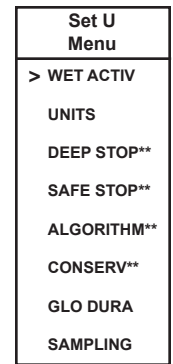

** NORM only



Fig. 45 - SET WET ACTIV

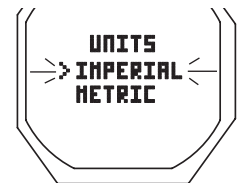

Fig. 46 - SET UNITS

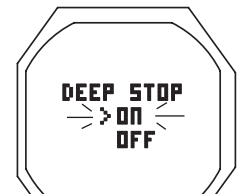

Fig. 47 - SET DEEP STOP



Fig. 48A - SET SAFETY STOP (TIMER)

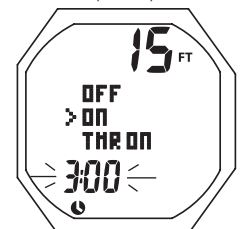

Fig. 48B - SET SAFETY STOP (TIME & DEPTH)



Fig. 49 - SET ALGORITHM

- A (< 2 sec) - to toggle Set Points.
- S (< 2 sec) - to save the setting and revert to the Set U Menu.

This feature allows selection of the algorithm used for nitrogen and oxygen calculations. Refer to page 26.

Set Conserv, information includes (Fig. 50):

- > Graphic CONSERV (= Conservative Factor).
- > Set Point graphics ON and OFF, Arrow (>) icon next to the one previously saved flashing.

- A (< 2 sec) - to toggle Set Points.
- S (< 2 sec) - to save the setting and revert to the Set U Menu.

When set On, NDLs are reduced to those of the next higher 3000 foot (915 meter) Altitude. Refer to the charts in the back.

Set Glo Dura, information includes (Fig. 51):

- > Graphics GLO (= Backlight) and DURATION.
- > Set Point 0 (or 5, 10, 30, 60) flashing with graphic SEC.

- A (< 2 sec) - to step upward through Set Points one at a time.
- M (< 2 sec) - to step back through Set Points one at a time.
- S (< 2 sec) - to save the setting and revert to the Set U Menu.

Glo Dura (Backlight Duration) is the time the backlight will remain On after L is released.

Set Sampling, information includes (Fig. 52):

- > Set Point graphics 2 SEC, 15 SEC, 30 SEC, and 60 SEC; Arrow (>) icon next to the one previously saved flashing.

- A (< 2 sec) - to step upward through Set Points one at a time.
- M (< 2 sec) - to step back through Set Points one at a time.
- S (< 2 sec) - to save the setting and revert to the Set U Menu.

Sampling is the rate data is sampled and stored for download to the associated PC Interface program. Refer to pages 9 & 54.

SELECT DIVE MODE

S (< 2 sec) - to access Set Dive Mode while the selection Arrow icon (>) is next to it on the NORM Menu

Information includes (Fig. 53):

- > Graphic SEL (= Select).
- > Graphics NORM MODE, GAUG MODE, and FREE MODE; Arrow (>) icon next to mode currently active.

- A (< 2 sec) - to step upward through selections one at a time.
- M (< 2 sec) - to step back through selections one at a time.
- S (< 2 sec) - to save the selection and access that mode's Surface Main screen.

NORM/GAUG HISTORY MODE

S (< 2 sec) - to access History 1 while the selection Arrow icon (>) is next to History on the NORM (or GAUG) Menu

History 1, information includes (Fig. 54):

- > Graphic HIST.
- > Total number dives ever recorded (up to 9999) with graphic DIVES, 0 if no dive yet.
- > Total hours of EDT (dive time) ever recorded (up to 9999) with graphic Hour and Time (clock) icon, 0 if < 1 hour.

- S (< 2 sec) - to access History 2.

History 2, information includes (Fig. 55):

- > Max Depth ever (up to 400 FT/120 M) with FT (or M) and MAX icons.
- > Graphic HIST.
- > Graphic SEA, or EL2 to EL7, highest Altitude at which a dive was conducted.
- > Temperature with ° icon and graphic F (or C), lowest recorded during any dive.

- S (< 2 sec) - to revert to NORM (or GAUG) Menu.

SERIAL NUMBER

S (< 2 sec) - to access while the selection Arrow icon (>) is next to it on the NORM Menu.

Information includes (Fig. 56):

- > Graphic SN (= Serial Number).
- > OCS's factory programmed SN.
- > Graphic r1A (or higher), indicating the revision level of the Firmware (OCS's operating software); followed by 01 (or higher), indicating the revision level of the Display.

- S (< 2 sec) - to revert to the GAUG Menu if in GAUG mode; or to access Clear (reset) if NORM, refer to page 54.
- S (2 sec) - to revert to the NORM if in NORM mode.

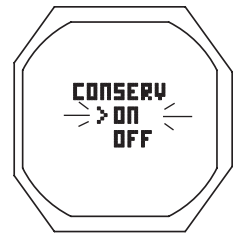

Fig. 50 - SET CONSERVATIVE FACTOR



Fig. 51 - SET BACKLIGHT DURATION

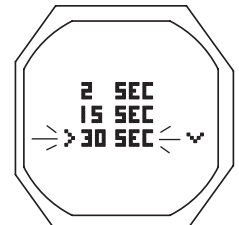

Fig. 52 - SET SAMPLING RATE



Fig. 53 - SELECT DIVE MODE



Fig. 54 - HISTORY 1



Fig. 55 - HISTORY 2



Fig. 56 - SERIAL NUMBER

DIVE MODE FEATURES

WET ACTIVATION

The OCS is configured with contacts that will automatically activate Dive Mode when the space between the contacts is bridged by a conductive material (immersed in water) and it senses a Depth of 5 FT (1.5 M) for 1 second.

The contacts are the metal pins of the PC Interface Data Port and the stems of the buttons.

When Wet Activation is set Off, the OCS will not enter Dive Mode while in Watch Mode unless a dive has already been conducted and it is a repetitive dive.

BACKLIGHT

Press L (Light) button to activate.

- The Backlight will be On for L depression time plus the Duration time set (0, 5, 10, 30, or 60 sec).
 - Press L while the light is On to reset the timer and keep it On for the full Duration.
 - Shuts Off if L is depressed for more than 10 sec.
- > Extensive use of the Backlight reduces Battery life.
 > The Backlight does not operate during a Low Battery condition (< 2.75 v), or when the Oceanlog PC Interface cable is connected to the OCS.

BAR GRAPHS

The OCS features 2 bar graphs, one on each side of the LCD.

- > The one on the left is dual function. It represents either Nitrogen loading or Oxygen accumulation. The icons NI and O2 identify which is displayed at that time.
- > Throughout this manual, it is referred to as the NIBG (or TLBG = Tissue Loading Bar Graph) or the O2BG.
- > Regardless of which parameter the Bar Graph is representing at the time, nitrogen and oxygen calculations will continue to be performed in the background.
- > The one on the right represents ascent rate. It is referred to as the VARI (= Variable Ascent Rate Indicator).

TLBG

The TLBG represents your relative No Decompression (Fig. 57a) or Decompression status (Fig. 58a). The lower 4 segments represent No Deco status and the fifth at the top indicates a Deco condition. As your Depth and Elapsed Dive Time increase, segments add; and as you ascend segments recede, indicating that additional no deco time is available.

The OCS monitors 12 different nitrogen compartments simultaneously and the TLBG displays the one that is in control of your dive at any given time.

O2BG

When operating in NORM Nitrox mode, the O2BG (Fig. 59a) will be displayed on an Alternate screen. It represents oxygen exposure, either oxygen accumulated during a dive or over a period of 24 hours.

As your oxygen exposure increases, segments will add to the O2BG, and as it decreases, they will begin to recede, indicating that additional exposure is allowed for that dive and 24 hour period.

The OCS will store O2 calculations for up to 10 dives conducted during a 24 hour period. If the limit for O2 is reached (100% = 300 OTU), all 5 segments of the O2BG will be displayed on the Main dive screen in place of the TLBG (Fig. 60a).

After surfacing, Plan Mode will not be available until the O2BG recedes into the normal zone (4 segments).

VARI

The VARI (Fig. 61a) provides a visual representation of ascent speed (i.e., an ascent speedometer).

The segments represent two sets of speeds which change at a reference depth of 60 FT (18 M). Refer to the chart.

When ascent is too fast, all segments will be displayed flashing (Fig. 62) until ascent is slowed.

⚠ WARNING: At depths greater than 60 FT (18 M), ascent rates should not exceed 60 FPM (18 MPM). At depths of 60 FT (18 M) and shallower, ascent rates should not exceed 30 FPM (9 MPM).

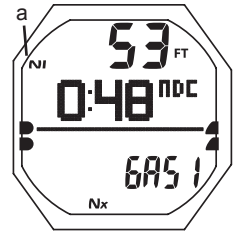

Fig. 57 - NO DECO

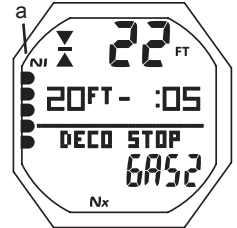

Fig. 58 - DECO

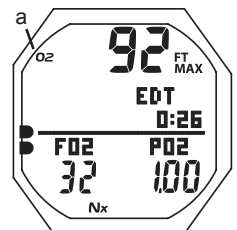

Fig. 59 - NO DECO ALT

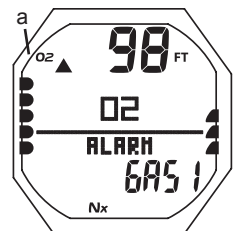

Fig. 60 - DIVE MAIN (High O2)

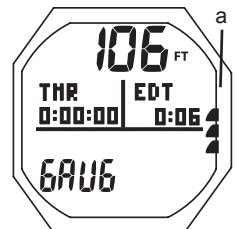

Fig. 61 - GAUG DIVE



Fig. 62 - DIVE MAIN (Ascent Too Fast)

Deeper than 60 FT (18 M)			60 FT (18 M) & Shallower		
Segments	Ascent Rate		Segments	Ascent Rate	
	FPM	MPM		FPM	MPM
0	0 - 20	0 - 6	0	0 - 10	0 - 3
1	21 - 30	6.1 - 9	1	11 - 15	3.1 - 4.5
2	31 - 40	9.1 - 12	2	16 - 20	4.6 - 6
3	41 - 50	12.1 - 15	3	21 - 25	6.1 - 7.5
4	51 - 60	15.1 - 18	4	26 - 30	7.6 - 9
5	60 +	18 +	5	30 +	9 +

ALGORITHM (Dual)

The OCS is configured with 2 algorithms which allows you to choose which set of NDLs (No Deco Limits) will be used for Ni/O₂ calculations and displays relating to Plan and DTR (Dive Time Remaining).

You can select DSAT or Z+. The selection will lock in for 24 hours after the last dive.

DSAT has been the standard used by Oceanic in all of its dive computers until this time. It features NDLs that are based on exposures and test data which also formed validation for the PADI RDP. It imposes restrictions for repetitive Deco dives, considered more risky.

Z+ (Pelagic Z+) performance is based on Buhlmann ZHL-16c. It features NDLs that are considerably more conservative especially at shallower depths.

To create even greater margins of safety with respect to decompression, a Conservative Factor as well as No Deco Deep and Safety Stops can be included for No Deco dives.

CONSERVATIVE FACTOR (CF)

When the CF is set On, the NDLs which are based on the algorithm selected and used for Ni/O₂ calculations and displays relating to Plan and DTR, will be reduced to the values available at the altitude level that is 3,000 feet (915 meters) higher.

DEEP STOP (DS)

When the DS selection is set On, it will trigger during NORM No Deco dives when you descend to 80 FT (24 M) and calculate (and continually update) a Stop Depth equal to 1/2 the Max Depth.

While 10 FT (3 M) deeper than the calculated DS, you will be able to access a DS Preview screen that will display the current DS Stop Depth/Time (fixed at 2 min) for 5 seconds then return to the Main.

Upon initial ascent to within 10 FT (3 M) below the calculated Stop Depth, a DS screen displaying a Stop Depth at 1/2 the Max Depth will appear with a Countdown Timer beginning at 2:00 (min:sec) and counting down to 0:00.

- > If you descend 10 FT (3 M) below, or ascend 10 FT (3 M) above, the calculated Stop Depth for 10 seconds during the countdown, the No Deco Main will replace the DS Main display and the DS feature will be disabled for the remainder of that dive. There is no Penalty if the DS is ignored.
- > In the event that you enter Deco, exceed 190 FT (57 M), or a High O₂ condition (=> 80%) occurs, the DS will be disabled for the remainder of that dive.
- > The DS is disabled during a High PO₂ Alarm condition (while => Set Point).

SAFETY STOP (SS)**If set On:**

Upon ascent to within 5 FT (1.5 M) deeper than the SS Depth set for 1 second on a No Deco dive in which Depth exceeded 30 FT (9 M) for 1 second, the audible will sound and a SS at the Depth set will be displayed with a countdown beginning at the SS Time set and counting down to 0:00 (min:sec).

- If the SS was set for OFF or Timer On, the display will not appear.
- In the event that you descend 10 FT (3 M) deeper than the Stop Depth for 10 seconds during the countdown, or the countdown reaches 0:00, the No Deco Main will replace the SS Main which will reappear upon ascent to within 5 FT (1.5 M) deeper than the Safety Stop Depth set for 1 second.
- In the event that you enter Deco during the dive, complete the Deco obligation, then descend below 30 FT (9 M); the SS Main will appear again upon ascent to within 5 FT (1.5 M) deeper than the SS Depth set for 1 second.
- If you surface prior to completing it, the SS will be canceled for the remainder of that dive.
- There is no Penalty if you surface prior to completing the SS or ignore it.

If set for Timer On:

Upon ascending to 20 FT (6 M) for 1 second on a No Deco dive in which Depth exceeded 30 FT (9 M) for 1 second, the audible will sound and a Run Timer will appear displaying 0:00 (min:sec) until started.

- If the SS was set for Off or On, the Timer display will not appear.
- If you descend deeper than 30 FT (9 M) for 10 seconds, the No Deco Main will replace the SS Timer screen which will reappear upon ascent to 20 FT (6 M) for 1 second.
- If you ascend above 10 FT (3 M) for 10 seconds, or enter Deco, or a High O₂ alarm condition occurs (100%), while the SS Timer is active, the SS Timer will be disabled for the remainder of that dive.
- If you surface prior to completing it, the SS will be canceled for the remainder of that dive.
- There is no Penalty if you surface prior to completing the SS or ignore it.

OVERVIEW OF FO₂ SETTINGS AND 50% DEFAULT

Refer to page 20 for Set F (FO₂) items. For each numeric value of FO₂ displayed on set screens, the MOD (Max Operating Depth) that can be achieved with the PO₂ Alarm set will be displayed.

FO₂ 50% Default (only for NORM Nitrox Dives)

When the FO₂ 50% Default is set On and FO₂ Gas 1 is set for a numerical value, 10 minutes on the surface after that dive the FO₂ Gas 1 will be displayed as 50 and further dives will be calculated based on 50% O₂ for oxygen calculations and 21% O₂ for Nitrogen calculations (79% Nitrogen) unless FO₂ Gas 1 is set before the dive.

FO₂ Gas 1 will continue to reset to the FO₂ 50% Default after subsequent repetitive dives until 24 hours elapse after the last dive, or the FO₂ 50% Default is set Off.

When the FO₂ 50% Default is set Off, the OCS will remain set at the last FO₂ Gas 1 Set Point for that period of activation.

FO2 set to Air

The default FO2 Gas 1 each new dive period will be Air. When FO2 Gas 1 is set for Air, calculations are the same as when FO2 is set for 21%. When FO2 Gas 1 is set for Air, it will remain set for Air until set for a numerical FO2 value (21 to 100%).

When FO2 Gas 1 is set for Air, the O2BG will not be displayed at any time during the dive, on the surface, or during the PDPS. PO2 will not be displayed during the dive.

The Max Operating Depth (MOD) will not be displayed on the FO2 set screen when Air is displayed.

Internally, the OCS will keep track of accumulated oxygen so that if FO2 for Gas 1 is subsequently set for Nitrox, O2 for previous Air dives will be accounted for in the next Nitrox dive (during that dive period and series of repetitive dives).

FO2 set for Nitrox

When FO2 for any Gas is set for a numerical value, the dive is considered Nitrox and the Nx icon will be displayed.

Once FO2 Gas 1 is set for a numerical value (21 to 100%), the Air option is disabled until 24 hours elapse after the last dive.

- The Air option will not be displayed in Set FO2 for Gas 1 until a full 24 hour Surface Interval has elapsed.
- If the FO2 50% Default is set Off, FO2 remains at the values set until changed. If the Default is set On, all FO2 values default to 50%.

DIVE TIME REMAINING (DTR)

The OCS constantly monitors No Deco status and O2 Accumulation, and will display whichever Time is the least amount available as DTR on the No Deco Dive Main screen (Fig. 63). The graphic NDC or OTR will identify the Time displayed.

No Deco DTR (NDC)

NDC is the maximum amount of time that you can stay at your present Depth before entering Deco. It is calculated based on the amount of Nitrogen absorbed by hypothetical tissue compartments. The rates each of these compartments absorb and release Nitrogen is mathematically modeled and compared against a maximum allowable Nitrogen level.

Whichever one is closest to this maximum level is the controlling compartment for that Depth. Its resulting value will be displayed NDC time (Fig. 63a) and graphically as the TLBG (Fig. 63b).

As you ascend, the TLBG segments will recede as control shifts to slower compartments. This is a feature of the Decompression Model that is the basis for Multilevel Diving, one of the most important advantages that Oceanic dive computers offer.

O2 DTR (OTR)

When the OCS is set for Nitrox operation, O2 accumulation during a dive, or 24 hour period, is displayed as the O2BG on an ALT screen (Fig. 64a). As time remaining before reaching the O2 Exposure Limit decreases, segments are added to the O2BG.

When the amount of time remaining before reaching the O2 Limit becomes less than the NDC, calculations for that Depth will be controlled by O2 and OTR will be displayed as DTR on the Main.

ERROR (RESET DURING A DIVE)

If for any reason, the OCS shuts Off then turns On again during any Dive, the graphic ERR (Error) will be displayed with the Up Arrow icon and current Depth with FT (or M) icon (Fig. 65).

If this occurs, it is highly recommended that you terminate the dive and begin a safe ascent to the surface.

Upon surfacing, ERR will be displayed for 5 seconds (Fig. 66) and operation will revert to Watch Mode.

Any time thereafter, when access to Dive Computer Operating Mode is attempted from Watch Mode, only the graphic ERR will be displayed and operation will revert to Watch Mode. No Dive Computer modes/screens will be accessible.

If this occurs, the OCS must be returned to the factory for evaluation/service prior to any further use for diving activities.

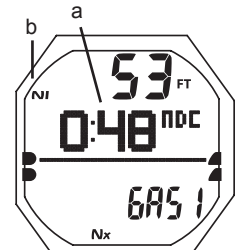

Fig. 63 -NO DECO MAIN

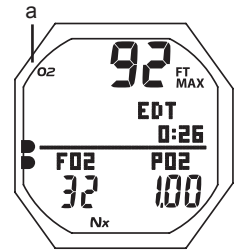

Fig. 64 -NO DECO ALT 1



Fig. 65 -ERROR (during dive)

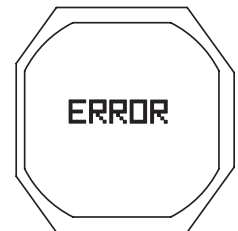

Fig. 66 -ERROR (after surfacing)

NORM

DIVE MODES

NO DECO MAIN, information includes (Fig. 67) -

- > Current Depth with FT (or M) icon, *or dashes during the first 10 minutes on the surface.
- > DTR (hr:min) with graphic NDC (or OTR), whichever is less at the time, *or dashes during the first 10 minutes on the surface.
- > *Surface Interval Time (hr:min) with graphic SURF and time (clock) icon during the first 10 minutes on the surface.
- > Graphic GAS1 (or 2 or 3), one in use.
- > Nx icon, if any Gas is set for Nitrox.
- > TLBG with NI icon.
- > VARI while ascending.

**The Dive Main continues to be displayed during the first 10 minutes after surfacing with access to Dive ALTs.*

- A (< 2 sec) to access ALTs.
- A (2 sec) to access Deep Stop Preview**, if triggered.
- M (< 2 sec) to access Gas Switching**.
- S (< 2 sec) to acknowledge alarms.
- S (2 sec) to access Compass**.
- L (press) to activate Backlight.

***These items can only be accessed while viewing the Main.*

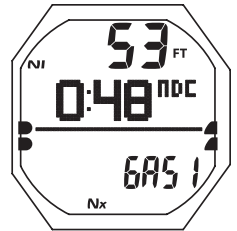

Fig. 67 - NO DECO MAIN

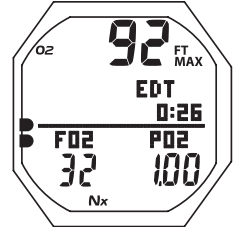

Fig. 68 - NO DECO ALT 1

No Deco Alt 1, information includes (Fig. 68) -

- > Max Depth with FT (or M) and MAX icons.
- > Elapsed Dive Time (hr:min) with graphic EDT.
- > FO2 Set Point for Gas in use with graphic FO2.
- > Current PO2 value (ATA) with graphic, if Nitrox.
- > Nx icon, if Nitrox.
- > O2BG with O2 icon, if Nitrox.

- A (< 2 sec) - to access ALT 2.
- Revert to Main in 5 sec, if A not pressed.



Fig. 69 - NO DECO ALT 2

No Deco Alt 2, information includes (Fig. 69) -

- > Time of Day (hr:min sec), with A (or P) if 12 Hour.
- > Temperature with ° icon and graphic F (or C).

- 5 sec or A (< 2 sec), revert to Main.

Deep Stop Preview, information includes (Fig. 70) -

- > Stop Depth with graphic FT (or M) and countdown Time as 2:00 (min:sec).
- > Graphic DEEP STOP.

- 5 sec, revert to No Deco Main.
- L (press) - to activate Backlight.

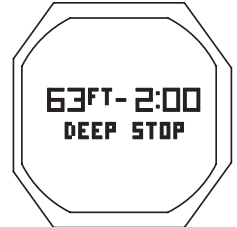

Fig. 70 - DEEP STOP PREVIEW

DEEP STOP MAIN, information includes (Fig. 71) -

- > Current Depth with FT (or M) icon.
- > Stop Depth with graphic FT (or M) and remaining countdown Time (min:sec).
- > Graphic GAS1 (or 2 or 3), one in use.
- > Nx icon, if any Gas is Nitrox.
- > TLBG with NI icon.

- A (< 2 sec) - to access ALTs.
- M (< 2 sec) - to access Gas Switching.
- S (< 2 sec) - to acknowledge alarms.
- S (2 sec) - to access Compass.
- L (press) - to activate Backlight.

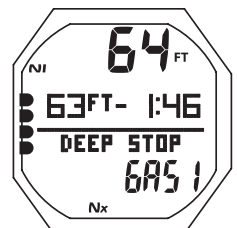

Fig. 71 - DEEP STOP MAIN

Deep Stop Alt 1, information includes (Fig. 72) -

- > Max Depth with MAX and FT (or M) icon.
- > DTR (hr:min) with graphic NDC (or OTR if less).
- > Elapsed Dive Time (hr:min) with graphic EDT.
- > FO2 Set Point for Gas in use with graphic FO2.
- > Current PO2 value (ATA) with graphic, if Nitrox.
- > Nx icon, if Nitrox.
- > O2BG with O2 icon, if Nitrox.

- A (< 2 sec) - to access ALT 2.
- Revert to Main in 5 sec, if A not pressed.

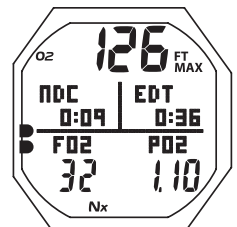

Fig. 72 - DEEP STOP ALT 1

Deep Stop Alt 2, information includes (Fig. 73) -

- > Time of Day (hr:min sec), with A (or P) if 12 Hour.
- > Temperature with ° icon and graphic F (or C).

- 5 sec or A (< 2 sec), revert to Main.



Fig. 73 - DEEP STOP ALT 2

SAFETY STOP MAIN (if Stop Depth/Time set On), information includes (Fig. 74) -

- > Current Depth with FT (or M) icon.
- > Stop Depth with FT (or M) and remaining countdown Time (min:sec).
- > Graphics SAFETY STOP and GAS1 (or 2 or 3), one in use.
- > Nx icon, if any Gas is Nitrox.
- > TLBG with NI icon.

- A (< 2 sec) - to access ALTs.
- M (< 2 sec) - to access Gas Switching.
- S (< 2 sec) - to acknowledge alarms.
- S (2 sec) - to access Compass.
- L (press) - to activate Backlight.



Fig. 74 - SAFETY STOP MAIN (Stop Depth/Time set)

SAFETY STOP MAIN (if set for Timer use), information includes (Fig. 75) -

- > Current Depth with FT (or M) icon.
- > Graphic TMR (= Timer) and Run Time counting up to 9:59 max (min:sec) then - : - - .
- > Graphic GAS1 (or 2 or 3), one in use.
- > Nx icon, if any Gas is Nitrox.
- > TLBG with NI icon.

- A (< 2 sec) - to access ALTs.
- M (< 2 sec) - to access Gas Switching.
- S (< 2 sec) - to acknowledge alarms.
- S (< 2 sec) - to Start/Stop the Timer, blocked when S if pressed to acknowledge alarms.
- A (2 sec), when the Timer is stopped - to reset it to 0:00.
- S (2 sec) - to access Compass.
- L (press) - to activate Backlight.

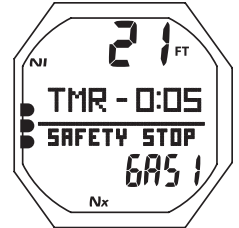

Fig. 75 - SAFETY STOP MAIN (set for Timer use)

Safety Stop Alt 1, information includes (Fig. 76) -

- > Max Depth with FT (or M) and MAX icons.
- > DTR (hr:min) with graphic NDC (or OTR if less).
- > Elapsed Dive Time (hr:min) with graphic EDT.
- > FO2 Set Point for Gas in use with graphic FO2.
- > Current PO2 value (ATA) with graphic, if Nitrox.
- > Nx icon, if Nitrox.
- > O2BG with O2 icon, if Nitrox.

- A (< 2 sec) - to access ALT 2.
- Revert to Main in 5 sec, if A is not pressed.

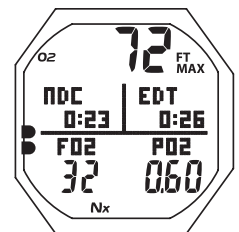

Fig. 76 - SAFETY STOP ALT 1

Safety Stop Alt 2, information includes (Fig. 77) -

- > Time of Day (hr:min sec), with A (or P) if 12 Hour.
- > Temperature with ° icon and graphic F (or C).

- 5 sec or A (< 2 sec), revert to Main.



Fig. 77 - SAFETY STOP ALT 2

DECOMPRESSION MODE

Decompression mode activates when theoretical No Decompression time and depth limits are exceeded.

Upon Entry into Deco, the Audible will sound and the LED will flash. The full TLBG and Up Arrow icon will flash (Fig. 78), until the Audible is silenced.

- S (< 2 sec) - to silence Audible.
 - > Up Arrow icon flashes if 10 FT (3 M) deeper than the required Stop Depth.
 - > Once within 10 FT (3 M) of and below the required Stop Depth (stop zone), the full Stop icon (both Arrows with Stop Bar) will be displayed solid.
- L (press) - to activate the Backlight.

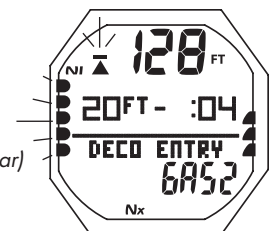

Fig. 78 - DECO ENTRY

Managing Deco Stops

To fulfill your decompression obligation, you should make a safe controlled Ascent to a depth slightly deeper than, or equal to, the required Stop Depth indicated and decompress for the Stop Time indicated.

The amount of decompression credit time that you receive is dependent on Depth, with slightly less credit given the deeper you are below the Stop Depth indicated.

You should stay slightly deeper than the required Stop Depth indicated until the next shallower Stop Depth appears. Then, you can slowly ascend to, but not shallower than that indicated Stop Depth.

DECO STOP MAIN, information includes (Fig. 79) -

- > Full Stop icon (Stop Bar with both Arrows) solid.
- > Current Depth with FT (or M) icon.
- > Stop Depth with graphic FT (or M) and remaining Stop Time (hr:min).
- > Graphics DECO STOP and GAS1 (or 2 or 3), one in use.
- > Nx icon, if any Gas is Nitrox.
- > Full TLBG with NI icon.

- A (< 2 sec) - to access ALTs.
- M (< 2 sec) - to access Gas Switching.
- S (< 2 sec) - to acknowledge alarms.
- S (2 sec) - to access Compass.
- L (press) - to activate Backlight.

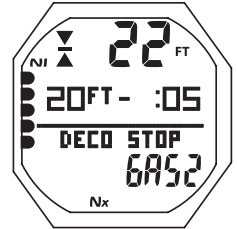

Fig. 79 - DECO STOP MAIN

Deco Stop Alt 1, information includes (Fig. 80) -

- > Max Depth with FT (or M) and MAX icons.
- > Graphic TAT with Total Ascent Time** (hr:min).
- > Elapsed Dive Time (hr:min) with graphic EDT.
- > FO2 Set Point for Gas in use with graphic FO2.
- > Current PO2 value (ATA) with graphic, if Nitrox.
- > Nx icon, if Nitrox.
- > O2BG with O2 icon, if Nitrox.

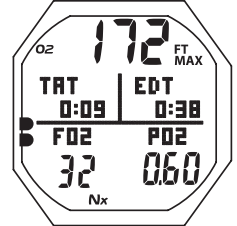

Fig. 80 - DECO STOP ALT 1

**TAT includes Stop Times at all required Deco Stops plus vertical Ascent Time based on the max rate allowed.

- A (< 2 sec) - to access ALT 2.
- Revert to Main in 5 sec, if A not pressed.

Deco Stop Alt 2, information includes (Fig. 81) -

- > Time of Day (hr:min sec), with A (or P) if 12 Hour.
- > Temperature with ° icon and graphic F (or C).



Fig. 81 - DECO STOP ALT 2

- 5 sec or A (< 2 sec), revert to Main.

CONDITIONAL VIOLATION (CV)

Upon ascent above the required Deco Stop Depth, operation will enter CV during which no off gassing credit will be given; with remaining Deco Stop Time and TAT freezing.

The Audible will sound and the LED will flash. The full TLBG and Down Arrow icon will flash (Fig. 82) until the Audible is silenced, then the TLBG will be solid.

- S (< 2 sec) - to silence Audible.
 - > The graphic ABOVE STOP will be displayed and the Down Arrow icon will flash until descent is made to below the required Stop Depth (within Stop Zone), then full the Stop icon (Stop Bar with both Arrows) will be on solid.
- L (press) - to activate the Backlight.

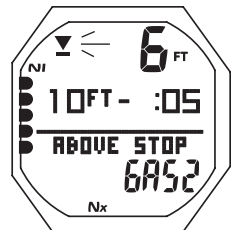

Fig. 82 - CV MAIN (after Audible)

If descent below the required Deco Stop Depth is made within 5 minutes, operation will resume in Deco with off gassing credit given (Stop Time and TAT decrease).

DELAYED VIOLATION 1 (DV1)

Once above the Deco Stop Depth for more than 5 minutes, operation will enter DV1 which is a continuation of CV**.

Again, the Audible will sound and the LED will flash. And, the full TLBG will flash (Fig. 83) until the Audible is silenced.

- > Down Arrow icon continues to flash until descent to below required Stop Depth (within Stop Zone), then full Stop icon (Stop Bar with both Arrows) will be on solid.
- L (press) - to activate the Backlight

When descent below the required Deco Stop Depth is made, operation will resume in Deco with off gassing credit given (Stop Time and TAT decrease).

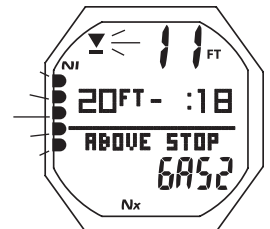

Fig. 83 - DV1 MAIN (during Audible)

**The difference between CV and DV1 is that DV1 causes operation to enter Violation Gauge Mode 5 minutes after surfacing from that dive.

CV & DV1 ALTs are similar to Deco.

DELAYED VIOLATION 2 (DV2)

If the Deco obligation requires a Stop Depth between 60 FT (18 M) and 70 FT (21 M), operation will enter DV2 (Fig. 84).

The Audible will sound and the LED will flash. The full TLBG will flash until the Audible is silenced.

- > Up Arrow icon flashes if 10 FT (3 M) deeper than the required Stop Depth.
- > Once within 10 FT (3 M) of and below the required Stop Depth (Stop Zone), the full Stop icon (both Arrows with Stop Bar) will be displayed solid.

- L (press) - to activate the Backlight.



Fig. 84 - DV2 MAIN

DELAYED VIOLATION 3 (DV3)

Upon descent deeper than the MOD** (330 FT/100 M), the Audible will sound and the LED will flash. Also, the Up Arrow will flash, and Current Depth and Max Depth will only indicate 3 dashes (- - -) signifying that you are Out of Range.

**MOD is the Max Operating Depth at which the OCS can accurately perform (NORM/FREE) nitrogen calculations.

Upon ascending above 330 FT (100 M), Current Depth will be restored, however, Max Depth (on ALT 1) will display 3 dashes for the remainder of that dive. Also, the Log for that dive will display 3 dashes as the Max Depth.

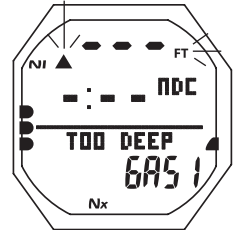

Fig. 85 - DV3 MAIN

DV3 MAIN, information includes (Fig. 85) -

- > Up Arrow icon, flashing.
- > Current Depth, 3 dashes (- - -) flashing, with FT (or M) icon.
- > DTR as 3 dashes (- : - -) with graphic NDC.
- > Graphics TOO DEEP and GAS1 (or 2 or 3), one in use.
- > Nx icon, if any Gas is Nitrox.
- > TLBG with NI icon.
- > VARI while ascending.

- A (< 2 sec) - to access ALTs.
- S (< 2 sec) - to acknowledge alarms.
- S (2 sec) - to access Compass.
- L (press) - to activate Backlight.

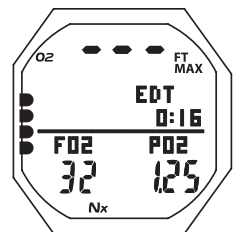

Fig. 86 - DV3 ALT 1

DV3 Alt 1, information includes (Fig. 86) -

- > Max Depth as 3 dashes (- - -) with FT (or M) and MAX icons.
- > Elapsed Dive Time (hr:min) with graphic EDT.
- > FO2 Set Point for Gas in use with graphic FO2.
- > Current PO2 value (ATA) with graphic, if Nitrox.
- > Nx icon, if Nitrox.
- > O2BG with O2 icon, if Nitrox.

- A (< 2 sec) - to access ALT 2.
- Revert to Main in 5 sec, if A not pressed.



Fig. 87 - DV3 ALT 2

DV3 Alt 2, information includes (Fig.87) -

- > Time of Day (hr:min sec), with A (or P) if 12 Hour.
- > Temperature with ° icon and graphic F (or C).

- 5 sec or A (< 2 sec), revert to Main.

VIOLATION GAUGE MODE (VGM)

If a Deco Stop Depth greater than 70 FT (21 M) is required, operation will enter VGM. This would be preceded by DV2.

Operation would then continue in VGM during the remainder of that dive and for 24 hours after surfacing. VGM turns the OCS into a digital instrument without any decompression or oxygen related calculations or displays. Gas Switching is terminated.

Upon activation of VGM, the Audible will sound and the LED will flash. The full TLBG and Up Arrow icon will flash.

VGM Main, information includes (Fig. 88/89) -

- > Up Arrow icon, flashing until on surface.
- > Current Depth with FT (or M) icon.
- > Graphic VIOL (in place of NDC) flashing until on surface.
- > TLBG, flashing during Audible then removed.
- > VARI while ascending.

- A (< 2 sec) - to access ALTs.
- S (< 2 sec) - to acknowledge alarms.
- S (2 sec) - to access Compass.
- L (press) - to activate Backlight.

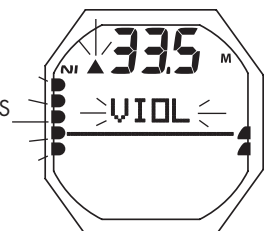

Fig. 88 - VGM MAIN (during Audible)



Fig. 89 - VGM MAIN (after Audible)

VGM Alt 1, information includes (Fig. 90) -

- > Max Depth with FT (or M) and MAX icons.
- > Graphic EDT with Elapsed Dive Time (hr:min).

- A (< 2 sec) - to access ALT 2.
- Revert to Main in 5 sec, if A not pressed.

VGM Alt 2, information includes (Fig. 91) -

- > Time of Day (hr:min sec), with A (or P) if 12 Hour.
- > Temperature with ° icon and graphic F (or C).

- 5 sec or A (< 2 sec), revert to Main.

VGM ON SURFACE

The graphic VIOL flashes for the first 10 minutes, then it alternates with NORM (each On 3 seconds, Fig. 92A/B) until DC shut down after 24 hours with no dives.

In the event that a dive is made during the 24 hour period, a full 24 hour surface interval must then be served before all functions are restored.

During that 24 hours, VGM does not allow access to the Set F, Plan, Dsat, and FREE Mode features/screens. All Watch and Compass functions will be allowed.

The Fly countdown timer provides the time remaining before normal operation can resume with full features and functions.

HIGH PO2

Warning >> at Alarm Set Point value minus .20 (1.00 to 1.40)

Alarm >> at Set Point value, except in Deco then at 1.60 only

When partial pressure of oxygen (PO2) increases to .20 less than the PO2 Alarm Set Point; the Audible sounds during which the graphic message WARNING will be displayed, the Up Arrow icon will flash, and the PO2 value with graphic PO2 will flash (in place of NDC) until the Audible is silenced (Fig. 93A).

- > After the Audible - NDC is restored, the graphic WARNING and Up Arrow icon remain on solid until PO2 decreases below .20 less than the Alarm Set Point then they are removed.

If PO2 continues to increase and reaches the PO2 Alarm Set Point, the Audible sounds again during which the graphic message ALARM will be displayed.

- > The PO2 value with graphic PO2 and Up Arrow icon will flash until PO2 decreases below the Alarm Set Point at which time the Warning information previously described will be displayed.

PO2 Alarm Main, information includes (Fig. 93B) -

- > Up Arrow icon, flashing until < Set Point, then solid.
- > Current Depth with FT (or M) icon.
- > PO2 value (ATA) with graphic PO2, flashing until < Set Point, then solid.
- > Graphic message ALARM until < Set Point, then WARNING.
- > Graphic GAS1 (or 2 or 3), one in use.
- > Nx icon.
- > TLBG with NI icon.
- > VARI while ascending.

- A (< 2 sec) - to access ALTs.
- S (< 2 sec) - to acknowledge alarms.
- S (2 sec) - to access Compass.
- M (< 2 sec) - to access Gas Switching.
- L (press) - to activate Backlight.

PO2 Alarm Alt 1, information includes (Fig. 94) -

- > Max Depth with FT (or M) and MAX icons.
- > DTR (hr:min) with graphic NDC (or OTR if less), 0:00 if PO2 is 1.60.
- > Elapsed Dive Time (hr:min) with graphic EDT.
- > FO2 Set Point for Gas in use with graphic FO2.
- > Current PO2 value (ATA) with graphic.
- > Nx icon.
- > O2BG with O2 icon.

- A (< 2 sec) - to access ALT 2.
- Revert to Main in 5 sec, if A not pressed.

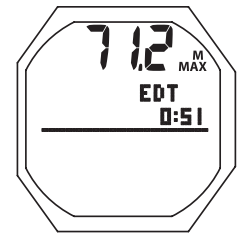

Fig. 90 - VGM ALT 1



Fig. 91 - VGM ALT 2



Fig. 92A - VGM SURF MAIN

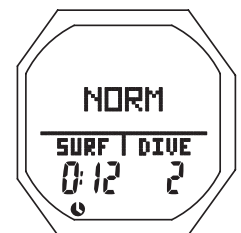

Fig. 92B - VGM SURF MAIN



Fig. 93A - PO2 WARNING (during Audible)



Fig. 93B - PO2 ALARM MAIN

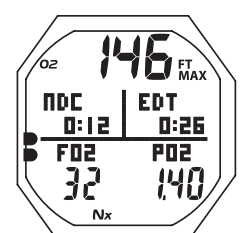

Fig. 94 - PO2 ALARM ALT 1

PO2 Alarm Alt 2, information includes (Fig. 95) -

- > Time of Day (hr:min sec), with A (or P) if 12 Hour.
- > Temperature with ° icon and graphic F (or C).

- 5 sec or A (< 2 sec), revert to Main.

PO2 during Deco

When in Deco, PO2 will only alarm at 1.60. The PO2 alarm settings do not apply and there is no warning at lower values.

- > If PO2 reaches 1.60 while at a Deco Stop, the audible will sound during which the PO2 value (1.60) with graphic PO2 will flash in place of Stop Depth/Time, and the graphic message ALARM will be displayed in place of DECO STOP.
- > When the audible is silent, PO2 information will alternate with Stop Depth/Time until PO2 decreases below 1.60 at which time the PO2 information will be removed.

HIGH O2

- Warning >> at 80% (240 OTU).
- Alarm >> at 100% (300 OTU).

O2 Warning Main, information includes (Fig. 97) -

- > Up Arrow icon, flashing until on surface.
- > Current Depth with FT (or M) icon.
- > Graphic O2, flashing in place of DTR until Audible is silenced, then DTR restored.
- > Graphic WARNING, on solid while the Audible sounds.
- > Graphic GAS1 (or 2 or 3), one in use.
- > Nx icon.
- > TLBG with NI icon, or O2BG with O2 icon if O2 time remaining is less.
- > VARI while ascending.

- A (< 2 sec) - to access ALTs.
- S (< 2 sec) - to acknowledge alarms.
- S (2 sec) - to access Compass.
- M (< 2 sec) - to access Gas Switching.
- L (press) - to activate Backlight .

O2 Alarm Main, information includes (Fig. 98) -

- > Up Arrow icon, flashing until on surface.
- > Current Depth with FT (or M) icon.
- > Graphic O2, flashing in place of DTR until on surface.
- > Graphic ALARM, on solid until on surface .
- > Graphic GAS1 (or 2 or 3), one in use.
- > Nx icon.
- > Full O2BG with O2 icon.
- > VARI while ascending.

- A (< 2 sec) - to access ALTs.
- S (< 2 sec) - to acknowledge alarms.
- S (2 sec) - to access Compass.
- M (< 2 sec) - to access Gas Switching.
- L (press) - to activate Backlight.

O2 Alt 1, information includes (Fig. 99) -

- > Max Depth with FT (or M) and MAX icons.
- > Elapsed Dive Time (hr:min) with graphic EDT.
- > FO2 Set Point for Gas in use with graphic FO2.
- > Current PO2 value (ATA) with graphic.
- > Nx icon.
- > TLBG with NI icon.

- A (< 2 sec) to access ALT 2
- Revert to Main in 5 sec, if A not pressed

O2 Alt 2, information includes (Fig. 100) -

- > Time of Day (hr:min sec) with A (or P) if 12 Hour.
- > Temperature with ° icon and graphic F (or C).

- 5 sec or A (< 2 sec), revert to Main.

High O2 during Deco

If a High O2 Warning (80%) occurs while at a Deco Stop, the graphics O2 (flashing) and WARNING (solid) will be displayed in place of Stop Depth/Time) until the Audible is silent, then Stop Depth/Time is restored.

If a High O2 Alarm (100%) strikes while at a Deco Stop, the graphics O2 (flashing) and ALARM (solid) will be displayed in place of Stop Depth/Time until on the surface. The Up Arrow icon will be displayed (flashing) until on the surface.



Fig. 95 - PO2 ALARM ALT 2



Fig. 96 - HIGH PO2 (100%) ALARM (during Deco)



Fig. 97 - HIGH O2 (80%) WARNING (during Audible)

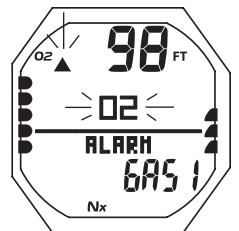

Fig. 98 - HIGH O2 (100%) ALARM MAIN

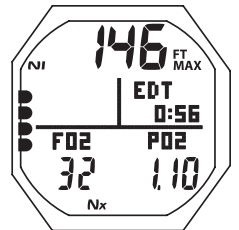

Fig. 99 - O2 ALARM ALT 1

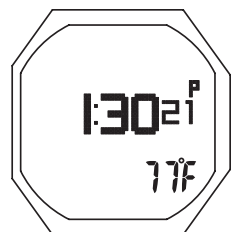

Fig. 100 - O2 ALARM ALT 2

O2 Alarm on Surface

The graphics O2 and ALARM are displayed solid (in place of NORM) until O2 decreases below 100%, then the NORM Surface Main screen is restored.

If High O2 occurred during Deco, the graphic O2 flashes with the graphic ALARM and full O2BG solid for the first 5 minutes, then the O2BG is removed and the graphics O2 and ALARM alternate with VIOL until O2 decreases below 100% or 10 minutes elapse, then the graphic O2 alternates with NORM until 24 hours elapse with no dive.

- > Operation enters VGM.
- > In the event that a dive is made during the 24 hour period, a full 24 hour surface interval must then be served before all functions are restored.
- > During that 24 hours, VGM does not allow access to the Set F, Plan, Desat, and FREE Mode features/screens. All Watch and Compass functions will be allowed.

⚠ WARNINGS

Decompression diving, or diving deeper than 130 FT (39 M), will greatly increase your risk of decompression sickness.

Decompression diving is inherently hazardous and greatly increases your risk of decompression sickness, even when performed according to the dive computer's calculations.

Using an OCS is no guarantee of avoiding decompression sickness.

The OCS enters Violation Mode when a situation exceeds its capacity to predict an ascent procedure. These dives represent gross excursions into decompression that are beyond the boundaries and spirit of the OCS's design. If you are following these dive profiles, Oceanic advises that you should not use an OCS.

If you exceed certain limits, the OCS will not be able to help you get safely back to the surface. These situations exceed tested limits and can result in loss of some functions for 24 hours after the dive in which a violation occurred.

NORM DIVE MODE STRUCTURE

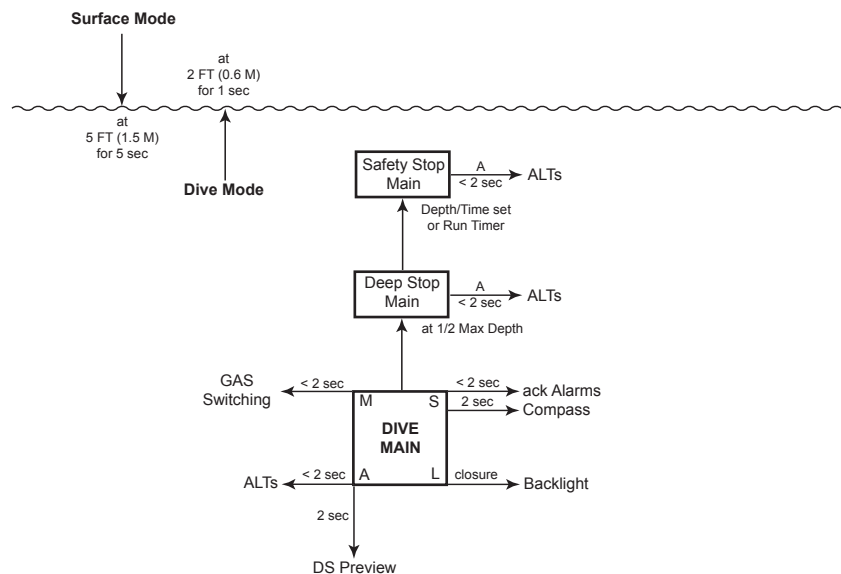

GAS SWITCHING

OVERVIEW

- > Can only switch when Dive Main screens are displayed.
- > Cannot Switch Gas on surface.
- > Cannot Switch Gas during alarms.
- > All NORM dives begin with Gas 1.
- > NORM mode defaults to Gas 1 after 10 minutes on the surface.

GAS Switch Menu, information includes (Fig. 101):

M (< 2 sec), while a NORM Dive Main is displayed - to access the Menu screen, if 2 or more gasses are set for use.

- > Graphic SEL.
- > Graphic selections GAS1, GAS2, GAS3 with FO2 settings. *The Arrow icon (>) next to the Gas currently in use at the time.*

A (< 2 sec) - to step down (forward) through selections.

M (< 2 sec) - to step up (back) through selections.

S (< 2 sec) - to access selection (the Switch To screen) indicated by Arrow icon (>). *No access provided if OFF.*

GAS Switch To, information includes (Fig. 102):

- > Graphics SWCH TO - ** GAS1 (or 2, or 3).
- > Graphic FO2 with Set Point.
- > Graphic PO2 with value calculated for that Gas' FO2.
- > Nx icon, if Nitrox.

- S (< 2 sec) - to Switch from the Gas in use to the Gas indicated, and revert to Main with the new Gas selected.

****Gas Switch Alarm**

If a switch to the new Gas would result in PO2 => 1.60, the Audible will sound and a warning message will flash (Fig. 103) until it is silenced, then the graphic SWCH TO - will be restored.

Due to the possibility that sufficient air may not be available in the Switch From tank, the switch will still be allowed.

If the switch is made, the PO2 alarm will strike. If in Deco, the Up Arrow icon will not flash (you control action to be taken).

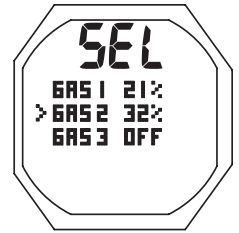

Fig. 101 - GAS SWITCH MENU



Fig. 102 - GAS SWITCH TO



Fig. 103 - GAS SWITCH ALARM

DIGITAL GAUG MODE STRUCTURE

SURFACE

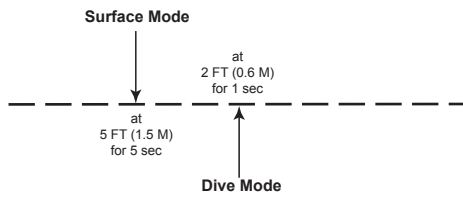
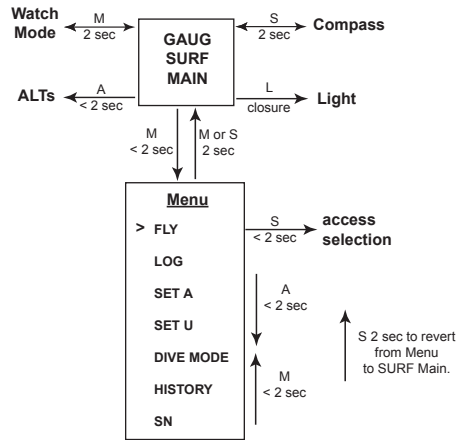

DIVE

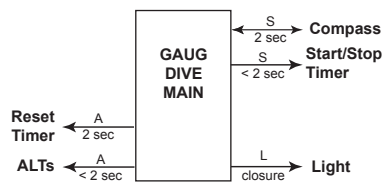

DIGITAL GAUGE

OP MODE

GAUG SURF MAIN, information includes (Fig. 104):

- > Graphic GAUG.
- > Graphic SURF and SI (hr:min) with Time (clock) icon; if no dive yet, this is time since access to GAUG.
- > Graphic DIVE and number of dives completed during that operating period, up to 24 (0 if no dive made yet).
- > Battery icon, if voltage is low.

- A (< 2 sec) - to access ALT 1.
- M (< 2 sec) - to access GAUG Menu.
- M (2 sec) - to access Watch Mode .
- S (2 sec) - to access Compass**.
- L (press) - to activate Backlight.

** Compass can only be accessed from Main.

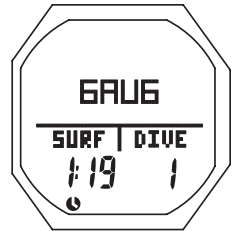

Fig. 104 - GAUG SURF MAIN

GAUG SURF ALT 1, information includes (Fig. 105):

- > Max Depth, of dive previously made or of that repetitive group, with FT (or M) and MAX icons, dashes (- -) if no dive.
- > Elapsed Dive Time (hr:min), of dive previously made or of that repetitive group, with graphic EDT, dashes (- : - -) if no dive.
- > Graphic LAST DIVE, indicating that data is from the dive previously conducted while in GAUG mode.

- A (< 2 sec) - to access ALT 2.
- 10 sec, revert to Main if A is not pressed.
- L (press) - to activate Backlight.

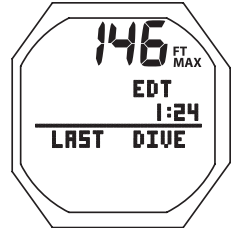

Fig. 105 - GAUG SURF ALT 1 (Last dive's data)

GAUG SURF ALT 2, information includes (Fig. 106):

- > Time of Day (hr: min sec) with A (or P).
- > Altitude graphic, if EL2 (to EL7), blank if Sea level.
- > Temperature with ° icon and graphic F (or C).

- 5 sec or A (< 2 sec), revert to Main.
- L (press) - to activate Backlight.



Fig. 106 - GAUG SURF ALT 2

GAUG MENU

- M (< 2 sec) - to access Menu, while viewing Surface Main.
- A (< 2 sec) - to step down (forward) through selections.
- M (< 2 sec) - to step up (back) through selections.
- S (< 2 sec) - to access selection indicated by Arrow icon (>).
- M (2 sec) any time while operating in the Menu system - to revert to Surface Main.
- S (2 sec) any time while viewing the Menu - to revert to Surface Main.
- 2 min no button action - will revert to Surface Main.

FLY TIME

Fly Time is a countdown timer that begins counting down 10 minutes after surfacing from a dive from 23:50 to 0:00 (hr:min).

The Fly countdown runs in the background while on the surface.

Information includes (Fig. 108):

- > Time to Fly (hr:min) with graphic FLY.
- > Time (clock) icon.

- 5 sec or S (< 2 sec), revert to Main.
- L (press) - to activate Backlight.

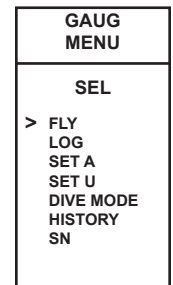

LOG, most SET A, and most SET U menu items are similar to those previously described for NORM. Refer to pages 19 to 23.

RUN TIMER

The GAUG Mode Set U Menu includes an item that allows a Run Timer to be added to the GAUG Dive Main screen.

Set Run Timer, information includes (Fig. 109):

- > Graphic RUN TIMER.
- > Set Point graphics ON and OFF; Arrow (>) icon next to the one previously saved flashing.

- A (< 2 sec) - to toggle Set Points.
- S (< 2 sec) - to save the setting and revert to the Set U Menu.

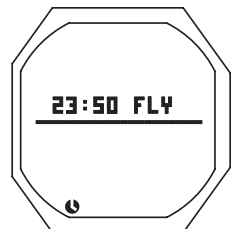

Fig. 108 - GAUG FLY (10 min after dive)

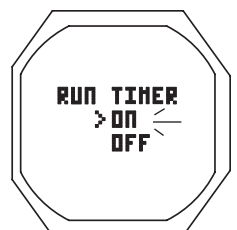

Fig. 109 - SET RUN TIMER

Upon descent to 5 FT (1.5 M) for 5 seconds, operation will enter GAUG Dive Mode.

GAUG DIVE MAIN, information includes (Fig. 110) -

- > Current Depth with FT (or M) icon.
- > Run Time (hr:min:sec) with graphic TMR (= Timer), 0:00:00 until started, up to 9:59:59; blank if set OFF.
- > Elapsed Dive Time (hr:min) with graphic EDT.
- > Graphic GAUG (= Mode).
- > VARI while ascending.

- S (2 sec) - to access Compass.
- S (< 2 sec) - to acknowledge Alarms.
- S (< 2 sec) - to start/stop Run Timer, if set ON; prevented if acknowledging Alarms.
- A (2 sec) - to reset Run Timer to 0:00:00, if set ON.
- A (< 2 sec) - to access ALT.
- L (press) - to activate Backlight.

GAUG DIVE ALT, information includes (Fig. 111) -

- > Max Depth with FT (or M) and MAX icons.
- > Time of Day (hr:min sec), with A (or P) if 12 Hour.
- > Temperature with ° icon and graphic F (or C).

- 5 sec or A (< 2 sec), revert to Main.

DELAYED VIOLATION 3 (DV3)

Upon descent deeper than the MOD (660 FT/200 M), the Audible will sound and the LED will flash. Also, the Up Arrow will flash, and Current Depth and Max Depth will only indicate 3 dashes (- - -) signifying that you are Out of Range.

Upon ascending above 660 FT (200 M), Current Depth will be restored, however, Max Depth (on ALT 1) will display 3 dashes for the remainder of that dive. Also, the Log for that dive will display 3 dashes as the Max Depth.

When operating in Digital Gauge Mode, the Depth range is extended to 660 FT (200 M).

DV3 MAIN, information includes (Fig. 112) -

- > Up Arrow icon, flashing.
- > Current Depth, 3 dashes (- - -) flashing, with FT (or M) icon.
- > Run Time (hr:min:sec) with graphic TMR, 0:00:00 until started, up to 9:59:59; blank if set OFF.
- > Elapsed Dive Time (hr:min) with graphic EDT.
- > Graphic TOO DEEP.
- > Graphic GAUG (= Mode).
- > VARI while ascending.

- S (2 sec) - to access Compass
- S (< 2 sec) - to acknowledge Alarms
- S (< 2 sec) - to start/stop Run Timer, if set ON; prevented if acknowledging Alarms
- A (2 sec) - to reset Run Timer, if set ON
- A (< 2 sec) - to access ALT
- L (press) - to activate Backlight

DV3 ALT, information includes (Fig. 113) -

- > Max Depth, 3 dashes (- - -), with FT (or M) and MAX icons.
- > Time of Day (hr:min sec), with A (or P) if 12 Hour.
- > Temperature with ° icon and graphic F (or C).

- 5 sec or A (< 2 sec), revert to Main.

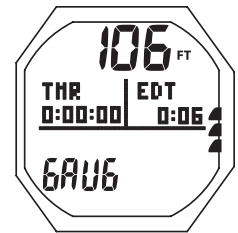

Fig. 110 - GAUG DIVE MAIN (Run Timer set ON)



Fig. 111 - GAUG DIVE ALT

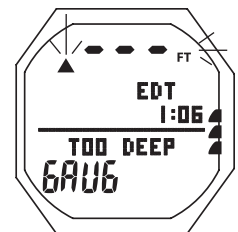

Fig. 112 - GAUG DV 3 MAIN (Run Timer set OFF)

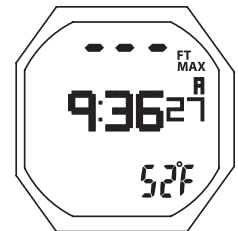
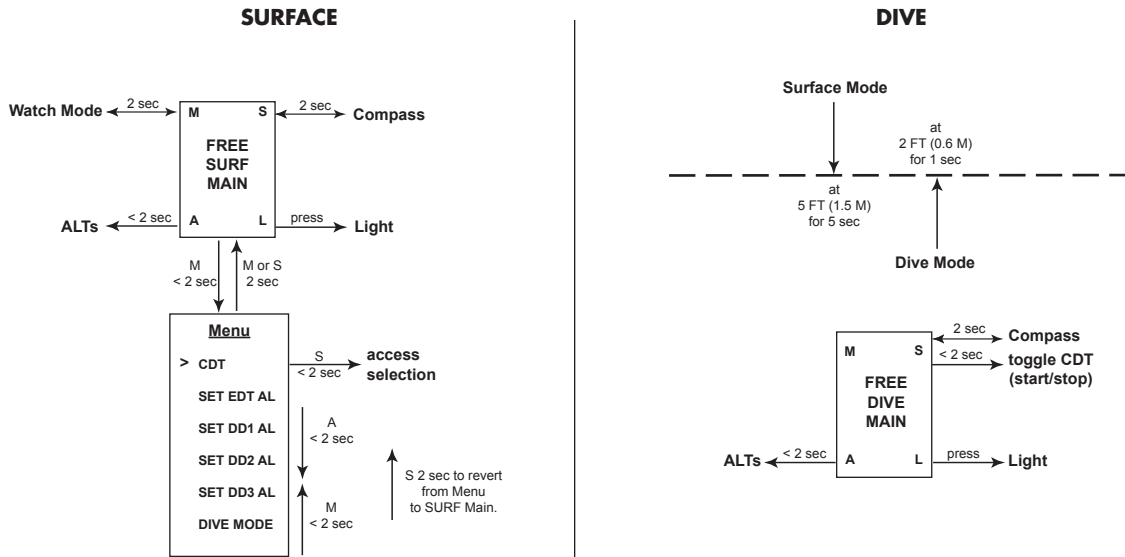

Fig. 113 - GAUG DV 3 ALT

FREE DIVE OP MODE

FREE DIVE MODE STRUCTURE



FREE SURF MAIN, information includes (Fig. 124A/B):

- > Graphic FREE.
- > Surface Interval (min:sec up to 59:59, then hr:min) with graphic SURF and Time (clock) icon
- > Number of dives completed during that set/series of repetitive dives with graphic DIVES, up to 99 (0 if no dive made yet).
- > TLBG with NI icon if any nitrogen remaining after NORM or FREE dives in past 24 hours.
- > Battery icon, if voltage is low.

- A (< 2 sec) - to access ALT 1 (ALT 2 if no dive yet).
- M (< 2 sec) - to access FREE Menu.
- M (2 sec) - to access Watch Mode.
- S (2 sec) - to access Compass**.
- L (press) to activate Backlight.

** Compass can only be accessed from Main.

FREE SURF ALT 1, information includes (Fig. 125):

- > Max Depth with FT (or M) and MAX icons, 2 dashes (--) if no previous dive
- > Elapsed Dive Time (min:sec) with graphic EDT, 3 dashes (-:-) if no previous dive
- > Graphic LAST DIVE, indicating that data is from the dive previously conducted while in FREE mode

- A (< 2 sec) - to access ALT 2.
- 10 sec, revert to Main if A is not pressed.
- L (press) - to activate Backlight.

FREE SURF ALT 2, information includes (Fig. 126):

- > Time of Day (hr: min sec) with A (or P).
- > Altitude graphic, if EL2 (to EL7), blank if Sea level.
- > Temperature with ° icon and graphic F (or C).

- 5 sec or A (< 2 sec), revert to Main.
- L (press) - to activate Backlight.



Fig. 124A - FREE SURF MAIN (no dive yet)



Fig. 124B - FREE SURF MAIN (34 min after dive 4)

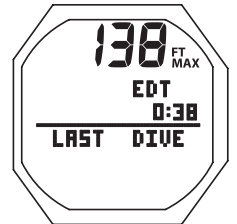

Fig. 125 - FREE SURF ALT 1 (Last dive's data)



Fig. 126 - FREE SURF ALT 2

FREE MENU

- M (< 2 sec) - to access Menu, while viewing Surface Main.
- A (< 2 sec) - to step down (forward) through selections.
- M (< 2 sec) - to step up (backward) through selections.
- S (< 2 sec) - to access selection indicated by Arrow icon (>).
- M (2 sec), any time while in the Menu system - to revert to Surface Main.
- S (2 sec), while viewing the Menu - to revert to Surface Main.
- 2 min (no button action) - will revert to Surface Main.

CDT (Countdown Timer) STATUS, information includes (Fig. 127A) -

- > Graphics CD TMR solid with OFF (or ON) flashing.
- > Countdown Time (hr:min). If OFF, 0:00 or the CDT time if previously set. If ON, the remaining time (min:sec).

- A (< 2 sec) - to step through selections OFF, ON, and SET.
- S (< 2 sec) - to save the selection that is flashing.
- S (2 sec) - to revert to FREE Menu.

- >> If OFF is selected, operation reverts to the Menu.
- >> If ON (start) is selected, operation reverts to the Menu with the time set starting to countdown.
- >> If SET is selected (Fig. 127B), Set CDT is accessed.

Set CDT, information includes (Fig. 128):

- > Graphics SET and CD TMR.
- > CDT (min:sec) with Minutes digits flashing.
- > Time (clock) icon.

- A (hold) - to scroll upward through Minute Set Points at a rate of 8 per second from 0: to 59: in increments of 1: (min).
- A (< 2 sec) - to step upward through Set Points one at a time.
- M (< 2 sec) - to step back through Set Points one at a time.
- S (< 2 sec) - to save the Minute Set Point and flash the Seconds digits.
- A (hold) - to scroll upward through Seconds Set Points at a rate of 8 per second from :00 to :59 in increments of :01 (sec).
- A (< 2 sec) - to step upward through Set Points one at a time
- M (< 2 sec) - to step back through Set Points one at a time.
- S (< 2 sec) - to save the CDT Set Point and revert to the CDT Status screen with SET flashing (similar to Fig. 127B).
- S (2 sec) - to revert to FREE Menu.

The CDT will run in the background, while on the surface and during dives, until it counts down to 0:00, or it is turned OFF.

When a set Countdown Time reaches 0:00, the Audible Alarm will sound during which time the graphic CDT will be displayed with 0:00 flashing on the Surface or Dive Main (Fig. 129).

EDT ALARM

Factory set for a fixed 30 seconds, the EDT (Elapsed Dive Time) alarm sounds the Audible every 30 seconds while underwater in FREE Dive Mode.

Set EDT Alarm, information includes (Fig. 130):

- > Graphic EDT.
- > Graphic OFF (or ON) flashing.

- A (< 2 sec) - to toggle OFF/ON.
- S (< 2 sec) - to save Set Point and revert to FREE Menu.
- S (2 sec) - to revert to FREE Menu.

DD ALARMS

There are 3 Descending Depth (DD) alarms that can be set at progressively deeper depths. DD2 values deeper than DD1, DD3 values deeper than DD2.

Set DD1 Alarm, information includes (Fig. 131):

- > Depth value with FT (or M) and MAX icons.
- > Graphics DD1 AL.
- > Graphic OFF (or ON) flashing.

- A (< 2 sec) - to toggle OFF/ON
- S (< 2 sec) - to save Set Point and flash Depth digits (if ON); or revert to FREE Menu (if OFF), bypassing DD2 and DD3.
- A (hold) - to scroll upward through Depth values at a rate of 8 per second from 30 to 330 FT (10 to 100 M) in increments of 10 FT (1 M)
- A (< 2 sec) - to step upward through Set Points one at a time.
- M (< 2 sec) - to step back through Set Points one at a time.
- S (< 2 sec) - to save the setting and revert to the FREE Menu.
- S (2 sec) - to revert to FREE Menu.



Fig. 127A - CDT STATUS (upon access)



Fig. 127B - CDT STATUS (to access Set, or set/ready)

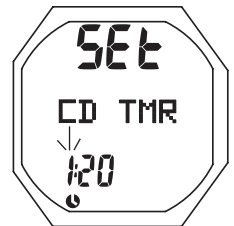

Fig. 128 - SET CDT (min:sec)



Fig. 129 - SURFACE MAIN (during CDT alarm)

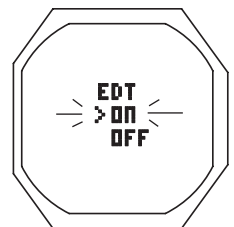

Fig. 130 - SET FREE EDT AL

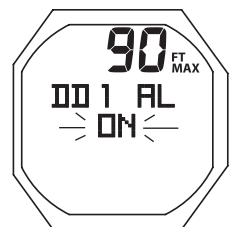

Fig. 131 - SET FREE DD1 AL

Set DD2 Alarm**, information includes (Fig. 132A):

- > Depth value with FT (or M) and MAX icons.
- > Graphics DD2 AL.
- > Graphic OFF (or ON) flashing.

- A (< 2 sec) - to toggle OFF/ON
- S (< 2 sec) - to save Set Point and flash Depth digits (if ON); or revert to FREE Menu (if OFF), bypassing DD3

** If this screen is accessed when DD1 is set Off, a message (Fig. 132B) will be displayed for 5 seconds, then operation will revert to the FREE Menu.

- A (hold) - to scroll up through Depth values at a rate of 8 per second, beginning 1 increment > DD1 Set Point (40 FT/11 M min) to 330 FT (100 M) in increments of 10 FT (1 M).
- A (< 2 sec) - to step upward through Set Points one at a time.
- M (< 2 sec) - to step back through Set Points one at a time.
- S (< 2 sec) - to save the setting and revert to the FREE Menu.
- S (2 sec) - to revert to FREE Menu.

Set DD3 Alarm**, information includes (Fig. 133A):

- > Depth value with MAX and FT (or M) icons.
- > Graphics DD3 AL.
- > Graphic OFF (or ON) flashing.

- A (< 2 sec) - to toggle OFF/ON.
- S (< 2 sec) - to save Set Point and flash Depth digits (if ON); or revert to FREE Menu (if OFF).

** If this screen is accessed when DD2 is set Off, a message (Fig. 133B) will be displayed for 5 seconds, then operation will revert to the FREE Menu.

- A (hold) - to scroll up through Depth values at a rate of 8 per second, beginning 1 increment > DD2 Set Point (50 FT/12 M min) to 330 FT (100 M) in increments of 10 FT (1 M).
- A (< 2 sec) - to step upward through Set Points one at a time.
- M (< 2 sec) - to step back through Set Points one at a time.
- S (< 2 sec) - to save the setting and revert to the FREE Menu.
- S (2 sec) - to revert to FREE Menu.

SELECT DIVE MODE

S (< 2 sec) - to access Set Dive Mode while the selection Arrow icon (>) is next to it on the FREE Menu

Set Dive Mode, information includes (Fig. 134):

- > Graphic SEL.
- > Set Point graphics NORM MODE, GAUG MODE, and FREE MODE; flashing when Arrow (>) icon is next to it.

- A (< 2 sec) - to step forward (down) through selections.
- M (< 2 sec) - to step back (up) through selections.
- S (< 2 sec) - to save the selection and access that mode's Surface Main screen
- S (2 sec) - to revert to FREE Menu.

To change items that FREE Mode shares with NORM Mode, access the NORM Menu, then Set U, then -

- > Wet Activation.
- > Units.
- > Algorithm.
- > Conservative Factor.
- > Glo Duration.

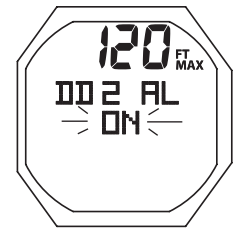

Fig. 132A - SET DD2 AL

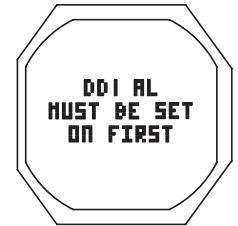

Fig. 132B - SET MESSAGE

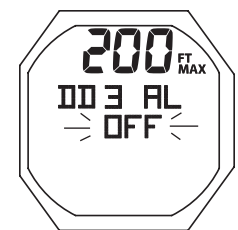

Fig. 133A - SET DD3 AL



Fig. 133B - SET MESSAGE



Fig. 134 - SELECT DIVE MODE

Upon descent to 5 FT (1.5 M) for 5 seconds, operation will enter FREE Dive Mode.

FREE DIVE MAIN, information includes (Fig. 135) -

- > Current Depth with FT (or M) icon.
- > No Deco Time Remaining (hr:min) with graphic NDC.
- > Elapsed Dive Time (min:sec) with graphic EDT.
- > TLBG with NI icon, if any from FREE or NORM dives within last 24 hours.

- S (2 sec) - to access Compass.
- A (< 2 sec) - to access ALT 1.
- L (press) - to activate Backlight.

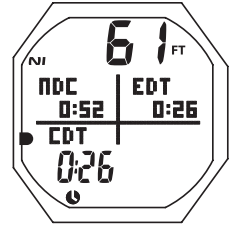

Fig. 135 - FREE DIVE MAIN

FREE DIVE ALT 1, information includes (Fig. 136) -

- > Graphics CD TMR (= Timer).
- > Status OFF (or ON) flashing.
- > Remaining CD Time (min:sec) with colon flashing if ON and a CD is in progress; 0:00 with colon flashing if the CD is complete; or OFF with the CD previously set.
- > Time (clock) icon.

- S (< 2 sec) - to toggle ON/OFF (start/stop Timer).
- A (< 2 sec) - to access ALT 2.
- Revert to Main in 10 sec, if A not pressed.

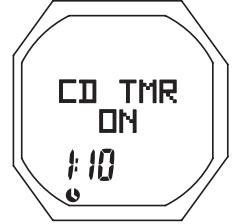

Fig. 136 - FREE DIVE ALT 1

The CDT will run in the background until it counts down to 0:00, or it is turned OFF.

FREE DIVE ALT 2, information includes (Fig. 137) -

- > Time of Day (hr:min sec), with A (or P) if 12 Hour.
- > Temperature with ° icon and graphic F (or C).

- 5 sec or A (< 2 sec), revert to Main.



Fig. 137 - FREE DIVE ALT 2

FREE DIVE ALARMS

FREE mode alarms, which are separate from NORM (or GAUG) alarms, sound 1 or 3 times as 3 short beeps then clear.

They cannot be acknowledged or silenced.

FREE CDT Alarm

When a set Countdown Time reaches 0:00, the Audible Alarm will sound during which time the graphic CDT will be displayed with 0:00 flashing on the Main screen (Fig. 138). The digits will stop flashing after the Audible.

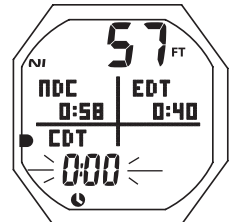

Fig. 138 - DIVE CDT AL

FREE EDT Alarm

When set ON, the EDT alarm activates every 30 seconds during a dive. The Audible will sound during which time the Time digits will flash on the Main (Fig. 139).

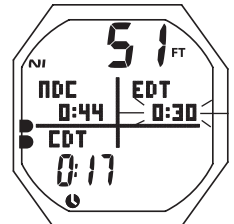

Fig. 139 - EDT AL

FREE Depth Alarms

When set ON, the DD alarms (1, 2, 3) activate at their set Depths. The Audible will sound during which time the Depth digits will flash on the Main (Fig. 140).

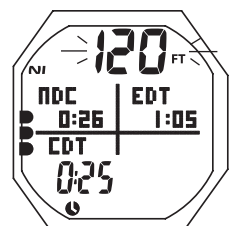

Fig. 140 - DD AL

High Nitrogen Alarms

When nitrogen increases to the caution level (4 segments), the Audible will sound during which time the TLBG and Up Arrow icon will flash on the Main (Fig. 141).

The Up Arrow icon remains on the display until on the surface.

In the event that nitrogen continues to increase and reaches the Deco level (Fig. 142A); all 5 TLBG segments, the Up Arrow icon, and the graphic VIOL, will flash while the Audible sounds. NDC will be displayed as 0:00.

When the Audible is silenced, the TLBG and NDC are removed (Fig. 142B). The Up Arrow icon flashes until on the surface and the graphic VIOL flashes (Fig. 143) until 1 minute elapses on the surface.

After 1 minute on the surface, the graphic VIOL alternates with FREE and dive computer operation locks into FREE Mode for 24 hours. Access to Watch and Compass will be as usual.

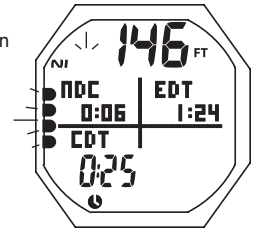

Fig. 141 - TLBG AL

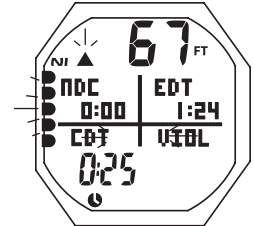

Fig. 142A - FREE VIOLATION (entry into Deco, during Aud)

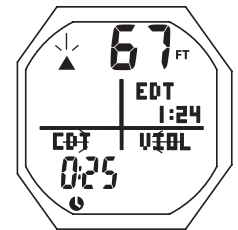

Fig. 142B - FREE VIOLATION (after Aud)

ADDITIONAL INFORMATION PERTAINING TO FREE DIVE MODE

Although breathing apparatus is not utilized for FREE Dive activities, nitrogen tissue loading remains a factor. Nitrogen loading is calculated based upon a fixed FO2 of AIR.

Since a user has the option of alternating between NORM (SCUBA) and FREE Dive activities within a 24 hour period, nitrogen calculations and the displayed value of No Deco Dive Time Remaining (NDC Time) are carried over from one operating mode to the other, which permits the user to maintain awareness of nitrogen absorption and offgasing status.

The mathematical models currently used in the OCS are based on no decompression/decompression multilevel repetitive dive schedules.

These algorithms do not take into account the physiological changes associated with the high pressures that competitive type Free diving can expose a diver to.



Fig. 143 - FREE VIOLATION (6 sec on surface)

⚠ WARNINGS

Ensure that you know which Operating Mode is selected (NORM, GAUG, or FREE) prior to commencing any dive.

Conducting Free dives within a 24 hour period after conducting SCUBA dives, combined with the effects of multiple rapid Free Dive ascents, increases your risk of decompression sickness. Such activities may result in accelerated entry into decompression which could cause serious injury or death.

Combining competitive type Free dive activities that involve multiple descents/ascents with activities utilizing SCUBA during the same 24 hour period is not recommended. Presently, there is no data relating to such activities.

It is highly recommended that anyone planning to become involved in competitive type Free dive activities obtain proper instruction and training from a recognized Free Diving trainer. It is imperative that the physiological affects be understood and the diver is physically prepared.

COMPASS MODE

COMPASS ICONS

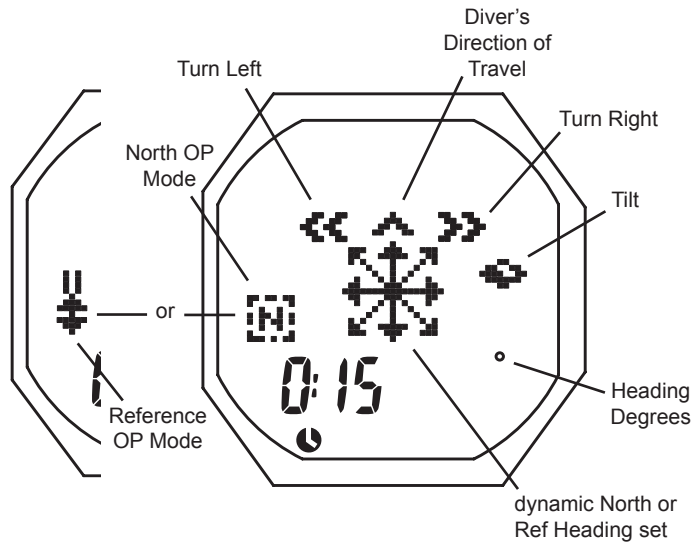

COMPASS MODE SURFACE

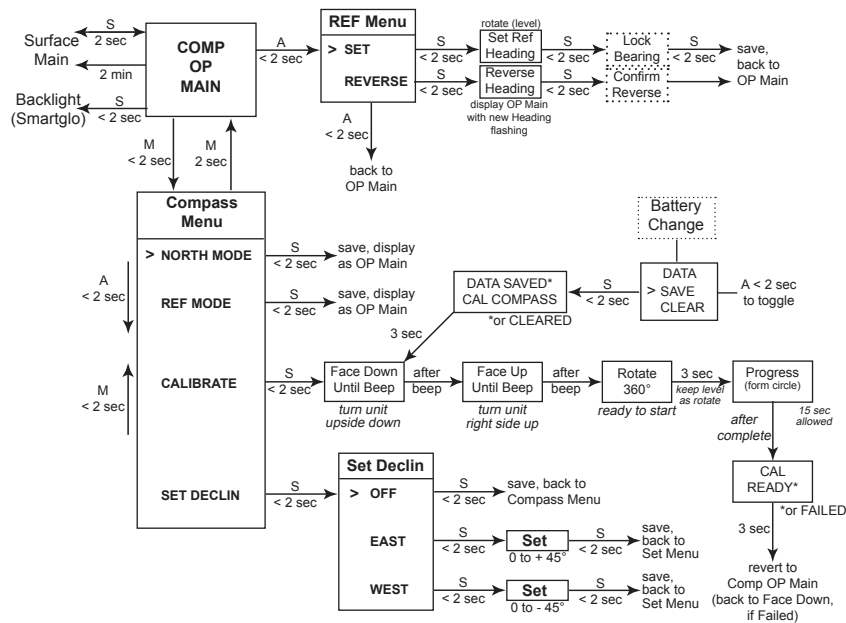

OVERVIEW

- > S (2 sec) - to access Compass OP Main from Watch, Surface, or Dive Main.
- > S (2 sec) or no button action (2 min*) - to revert to Watch, Surface, or Dive Main.

*During the final 15 seconds, the remaining On time is displayed. If a button is pressed during that time, the 2 minute On time will reset allowing operation to remain in Compass Mode.

- > Compass OP Mode selected (North, Reference) - remains until changed.
- > Reference OP Mode - can set a course, then also select a Reverse course while on the surface and during dives.
- > Numeric values are displayed as 3 digits (000 to 360°), have a resolution of 001°, and an accuracy of +/- 005°.
- > Operation will be normal and display of values will be within specified tolerances up to 90° tilt at which time the Heading (diver's direction) digits are removed until the tilt angle is within tolerance.

Upon accessing the Compass, the OP (operating) Main of the last mode selected will be displayed >> North (Fig. 144), Reference (Fig. 145), or Reverse Reference (Fig. 146).

While on the surface, press M (< 2 sec) to access the Compass Menu to change the OP Mode, Calibrate, or set Declination.

COMPASS MENU, information includes (Fig. 147) -

- > Graphics SEL (select) and MENU, with selections ->
- > NORTH MODE - select as OP Mode with no set heading.
- > REF MODE - select as OP Mode with set heading allowed.
- > CALIBRATE - access to initiate Calibration.
- > SET DECLIN - access to set Declination.
- > Compass On time remaining, counting down from 15 to 0 (sec), blank when > 15 seconds.

- A (< 2 sec) - to step forward (down) through selections.
- M (< 2 sec) - to step back (up) through selections
- S (< 2 sec) - to select or access item indicated by (>) icon.

If NORTH or REF MODE is selected, that mode will be saved and its OP Main will be displayed.

- M or S (2 sec) any time, except while in Calibration - to revert to Compass OP Main.
- No button action (2 min) - revert to Watch, Surface, or Dive Main.

NORTH OP MAIN, information includes (Fig. 148) -

- > Current Depth with FT (or M) icon, during dive mode, 00 during first 10 min on surface, blank on surface > 10 min.
- > North Mode icon (letter N in box).
- > Static Arrow icon (at 12 o'clock), diver direction of travel.
- > Dynamic Arrow, relative direction of magnetic North.
- > Tilt icon*, when the Compass is at an angle => 20° off level.
- > Numeric heading (diver's current direction), 001 to 360°, with position graphic (N, E, SE, etc.). *Blank when the Tilt icon is displayed.
- > On time remaining, counting down, if 15 to 0 (sec).

- S (2 sec) or no button action during 2 min - to revert to Watch, Surface, or Dive Main.
- L (press) - to activate Backlight.
- M (< 2 sec) - to access Compass Menu, surface only.

REFERENCE OP MAIN, information includes (Fig. 149) -

- > Current Depth with FT (or M) icon, during dive mode, 00 during first 10 min on surface, blank on surface > 10 min.
- > Reference Mode icon (2 bars with arrow, Fig. 149a) with numeric Reference heading (course) set above it.
- > Static Arrow icon (at 12 o'clock), diver direction of travel.
- > Turn Arrow icon (left or right) flashing during any time the diver deviates => 10° off the heading set.
- > Dynamic Arrow, tracking Reference direction set.
- > Tilt icon*, when the Compass is at an angle => 20° off level.
- > Numeric heading (diver's current direction), 001 to 360°, with position graphic (N, E, SE, etc.). *Blank when the Tilt icon is displayed.
- > On time remaining, counting down, if 15 to 0 (sec).

- S (2 sec) or no button action during 2 min - revert to Watch, Surface, or Dive Main.
- L (press) - to activate Backlight.
- M (< 2 sec) - to access Compass Menu, surface only.
- A (< 2 sec) - to access Reference Menu, surface or dive.

REFERENCE MENU, information includes (Fig. 150) -

- > Graphic SEt, with selections ->
- > REF HEADING - To access REF OP Main with the Heading flashing allowing it to be set.
- > REVERSE HEADING - To select it as the OP Mode with new Heading (180° opposite of Reference Heading set).
- > On time remaining, counting down, if 15 to 0 (sec).

- A (< 2 sec) - to toggle selection.
- S (< 2 sec) - to save the selection and revert to OP Main.

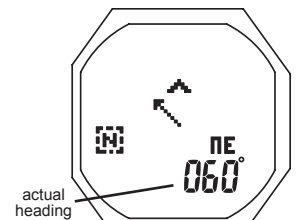

Fig. 144 - NORTH OP MODE

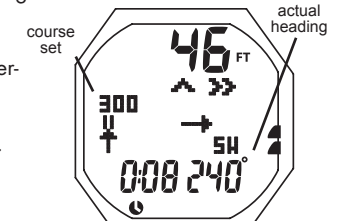

Fig. 145 - REF OP MODE

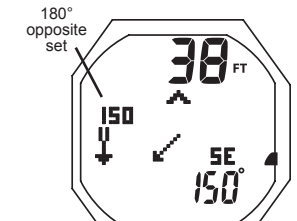

Fig. 146 - REVERSE REF



Fig. 147 - COMPASS MENU



Fig. 148 - NORTH OP MAIN (at 280°)

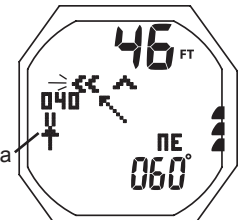

Fig. 149 - REF OP MAIN (at 060°, turn left to 040°)



Fig. 150 - REF MENU

Set Reference Heading, information includes (Fig. 151) -

- > Current Depth with FT (or M) icon, blank on surface.
- > Reference Mode icon (2 bars with arrow) with graphic SET (flashing) above it.
- > Static Arrow icon (at 12 o'clock), diver direction of travel.
- > Dynamic Arrow, tracking Reference direction currently set.
- > Numeric heading (diver's direction) at lower/right, with position graphic.
- > On time remaining, counting down, if 15 to 0 (sec).

- S (< 2 sec) - to flash Heading value (lower/right), with SET solid.
- Rotate the Compass (keeping level) in either direction to new Heading, at lower/right.
- S (< 2 sec) - to lock in new Heading, replacing SET.

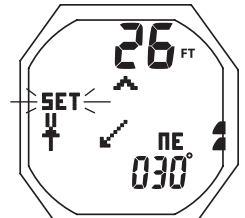

Fig. 151 - SET REFERENCE HEADING
(rotate to desired Heading)

Reverse Ref Heading, information includes (Fig. 152) -

- > Current Depth with FT (or M) icon, blank on surface.
- > Reverse Mode icon (2 bars with arrow) with reverse Heading (180° opposite of Reference Heading set) above it, flashing.
- > Static Arrow icon (at 12 o'clock), diver direction of travel.
- > Dynamic Arrow, tracking Reference direction currently set.
- > Numeric heading (diver's direction) at lower/right, with position graphic.
- > On time remaining, counting down, if 15 to 0 (sec).

- S (< 2 sec) - to reverse Heading.

The value above the Reverse Mode icon (new course) will stop flashing indicating the Heading has been reversed.

The value at the lower/right will then indicate actual current direction.

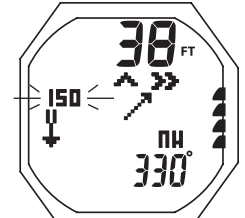

Fig. 152 - REVERSE REF HEADING
(reverse from 330°, to 150°)

CALIBRATION (surface only)

Local magnetic fields can effect display of actual location when reading a digital compass. It may be advantageous to Calibrate the Compass before its first use after purchase, use in new regions, or if inaccuracies are experienced. Calibration will be required when the battery is changed.

CAL Access/Start**, information includes (Fig. 153) -

- > Graphics CAL and ROTATE.
- > 360 with ° icon.

- S (< 2 sec) - to activate (start) Calibration.
- Slowly and steadily rotate the unit 360° in either direction while maintaining it in a flat level position (keeping it level is critical for accuracy), CAL progress will be displayed.

** The CAL ROTATE screen will also be accessed after the Battery is changed and Data is either saved or cleared.

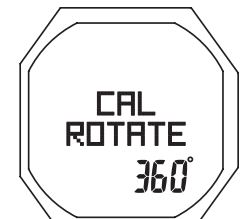

Fig. 153 - START CAL

CAL Progress**, information includes (Fig. 154) -

- > Graphic CAL.
- > dotted circle, increasing from 0 to 360° as it is rotated.

**Rotation should take about 30 seconds. If not fully rotated in 60 seconds, operation will revert to the Menu.

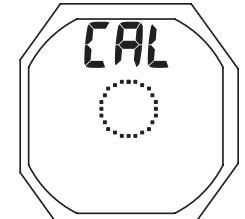

Fig. 154 - PROGRESS
(turn until full circle)

CAL Complete, information includes (Fig. 155, 156) -

- > Graphic CAL.
- > Graphic READY or AGAIN, flashing for 3 seconds.

* READY, means it passed, in which case Calibration is complete and operation reverts to the OP Main.

* AGAIN, means it failed**, in which case the CAL ROTATE screen will be displayed. Press S (< 2 sec) to repeat Calibration.

**If Calibration fails after 3 attempts, operation will revert to the Watch or Surface Main from which it was accessed. If you then continue operation, the previous successful Calibration will remain in effect.



Fig. 155 - TO START CAL



Fig. 156 - CAL PASSED

DECLINATION

Magnetic Declination is taken from numbers provided on maps or charts that apply to a specific location. The numbers represent the easterly or westerly angular difference (Declination) in degrees between magnetic North and true (geometric or polar) North. A Compass will point to magnetic North unless its reference is adjusted to true North prior to conducting activities.

Declination Menu, information includes (Fig. 157) -

- > Graphic SEt, with selections -
- > DECLIN OFF.
- > DECLIN EAST.
- > DECLIN WEST.

- A (< 2 sec) - to step forward (down) through Menu selections.
- M (< 2 sec) - to step back (up) through Menu selections.
- S (< 2 sec), when the pointer icon (>) is next a selection - to select it.



Fig. 157 - DECLIN MENU

- > If OFF is selected, Declination is set for 0° and operation reverts to the Compass Menu.
 - > If DECLIN EAST (or WEST) is selected, the Set Declination screen is accessed with the setting flashing (Fig. 158).
- A (hold) - to scroll upward through Set Points at a rate of 4 per second from 0 to 45° in increments of 1°.
 - A (< 2 sec) - to increase Set Points one at a time.
 - M (< 2 sec) - to step back through Set Points one at a time.
 - S (< 2 sec) - to save the Set Point and revert to the Set Declination Menu.



Fig. 158 - SET DECLINATION

ALARMS

When most Alarms strike, operation in Compass Mode will be terminated and the Dive Main will be displayed indicating the alarm condition. Compass Mode can then be reentered by pressing S (2 sec).

During several types of alarms, indication will be given while remaining in Compass Mode without interruption. They are -

Ascent Alarm (Fig. 159) -

- > VARI, all segments flashing until slowed.

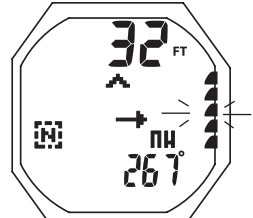

Fig. 159 - ASCENT ALARM

Depth Alarm (Fig. 160) -

- > Depth digits flash until shallower than the alarm depth set.



Fig. 160 - DEPTH ALARM



WARNING: You must become thoroughly familiar with setup and operation of the OCS Digital Compass before using it as your primary device for navigation. Failure to do so could result in serious errors relating to activities involving navigation.

- > Practice on land before use in water.
- > Practice on the surface before use underwater.

REFERENCE



CAUTION: When the procedure provided in this section is used to change the Battery, you must be sure that the case o-ring is not pinched and that the OCS is water tight before conducting diving activities. Pre dive pressure testing by an Authorized Oceanic facility is highly recommended.

PC INTERFACE

The Settings Upload portion of the Oceanlog PC Interface (PCI) program can be used to set/change the Main Time, Date, Set A group (Alarms), and Set U group (Utilities) using the Interface System. The Set F group (FO2) and FREE Mode Alarms must be entered using the OCS's button controls.

Information available for retrieval (download) from the OCS to the PC program includes dive number, SI, max depth, EDT, start date/time, lowest temperature, sampling rate, dive profile, Set Points, TLBG, O2BG, and Gas Switching events.

Prior to attempting to download data from your OCS or upload settings to it, review the Help section of the PCI program. Recommended is to print those sections of Help that you consider appropriate for your Interface activities.

A USB Driver is provided on the Oceanlog CD as part of the Interface System.

The OCS is configured with a Data Port located on the side (Fig. 161a) that enables it to be connected to a PC USB port using the special Interface Cable.

To connect the PCI Cable to the OCS:

- > position the connector with the red dot at 12 o'clock.
- > align the pins of the cable connector with the holes in the data port and press the connector into the port (Fig. 162).
- > turn the connector clockwise until the red dot is at 1 o'clock and it locks in (Fig. 163), then release it.

The OCS checks for a connection to the Data Port once every second while the Watch Default Time is displayed. Checks are not made if the Wet Activation contacts are wet.

When the PCI cable is plugged in, the graphic PC COMM is displayed with a 2 minute countdown timer that runs until the connection is confirmed, then the graphics PC COMM CONNECTED are displayed until completion of the upload or download operation.

PC Requirements:

- IBM®, or compatible, Personal Computer with USB Port
- Intel® Pentium 200 MHz or better microprocessor
- Microsoft® Windows® XP, Vista, or 7.
- Super VGA card or compatible video graphics adaptor (256 color or greater) with a minimum 800 X 600 pixel screen area of display settings
- 16MB of available RAM
- 20MB of available hard drive storage
- Mouse
- CD Rom drive
- Printer

For software updates, refer to the Oceanic web site at -

www.OceanicWorldwide.com

For support, call OceanLog Support toll free at -

(866) 732-7877, 8 Am to 5 Pm USA Pacific time.

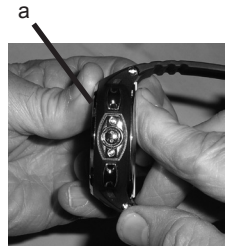

Fig. 161 - PC DATA PORT



Fig. 162 - PCI CABLE (insert with dot at 12 o'clock)

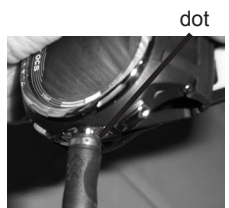
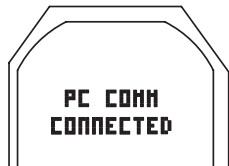

Fig. 163 - PCI CABLE (turned, dot at 1 o'clock)



TIMER (counting down)



PCI CABLE (connection sensed)

CLEAR (RESET)

The OCS is configured with a feature that allows nitrogen and oxygen calculations to be cleared. ***This is intended for facilities using the OCS for rental or training activities, not for general use by individual divers.***

⚠ WARNING: Reset after a dive and subsequent use for a repetitive dive conducted by the same diver could result in serious injury or death.

Upon accessing the Clear screen, information displayed includes >> the graphics CLr CAUTION DELETES NI-O2 with an arbitrary invalid code number entered by the factory, all solid. Proceed as follows, or press S (2 sec) return to the SN screen

Reset procedure:

- S (2 sec), at any time, to cancel the procedure and revert to the SN screen.
- S (< 2 sec) to start the first 2 digits (left) flashing.
- A (hold) to scroll upward through the first digits (left) at a rate of 8 per second.
- A (< 2 sec) to step upward through the digits (left) one at a time.
- M (< 2 sec) to step back through the digits (left) one at a time.
- S (< 2 sec) to save the first 2 digits (left) and start the second 2 digits (right) flashing.
- A (hold) to scroll upward through the second digits (right) at a rate of 8 per second.
- A (< 2 sec) to step upward through the digits (right) one at a time.
- M (< 2 sec) to step back through the digits (right) one at a time.
- S (< 2 sec) to save the reset code, clear the NI-O2 calculations, and revert to Watch mode.

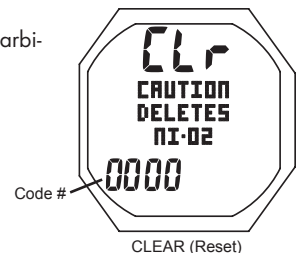

CLEAR (Reset)

CARE AND CLEANING

Protect your OCS from shock, excessive temperatures, exposure to chemicals, and tampering. Protect the lens against scratches with a Instrument Lens Protector. Small scratches will naturally disappear underwater.

- Soak and rinse the OCS in fresh water at the end of each day of diving, and check to ensure that the areas around the Low Pressure (Depth) Sensor (Fig. 164a), PC Interface Data Port (Fig. 164b), and Buttons are free of debris or obstructions.
- To dissolve salt crystals, use lukewarm water or a slightly acidic bath (50% white vinegar/50% fresh water). After removal from the bath, place the OCS under gently running fresh water and towel dry before storing.
- Transport your OCS cool, dry, and protected.

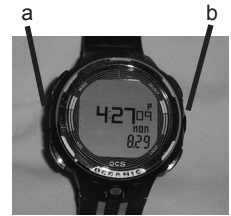

Fig. 164 - FRONT

INSPECTIONS AND SERVICE

Your OCS should be inspected annually by an Authorized Oceanic Dealer who will perform a factory prescribed function check and inspection for damage or wear. To keep the 2 year limited warranty in effect, this inspection must be completed one year after purchase (+/- 30 days).

Oceanic recommends that you continue to have an inspection performed every year to ensure it is working properly. The costs of annual inspections, or inspections relating to water tight integrity, are not covered under the terms of the 2 year limited warranty.

To Obtain Service:

Take your OCS to an Authorized Oceanic Dealer or send it to the nearest Oceanic Regional Facility.

To return your OCS to Oceanic:

- Record all dive data in the Log and/or download the data stored in memory. All data will be erased during factory service.
- Package it using a protective cushioning material.
- Include a legible note stating the specific reason for return, your name, address, daytime phone number, serial number(s), and a copy of your original sales receipt and Warranty Registration Card.
- Send freight prepaid and insured using a traceable method to the nearest Oceanic Regional Facility, or to Oceanic USA.
- If shipping to Oceanic USA, obtain an RA (Return Authorization) number by contacting Oceanic at 510/562-0500 or send an e-mail to service@oceanicusa.com.
- Non-warranty service must be prepaid. COD is not accepted.
- Additional information is available at the Oceanic web site OceanicWorldwide.com

BATTERY REPLACEMENT

CAUTION: The procedures that follow must be closely adhered to avoid entrance of water into the unit. Damage due to improper Battery replacement (or subsequent leakage of moisture into the unit) is not covered by the OCS's 2 year warranty.

NOTE: The OCS can be sent to Oceanic Worldwide, Regional Distributor, or Authorized Dealer Service for proper battery change service which includes pressure (depth) and leak testing to the max operating depth. Standard charges for service will apply

The Battery Compartment should only be opened in a dry and clean environment with extreme care taken to prevent the entrance of moisture or dust.

As an additional precautionary measure to prevent formation of moisture in the Battery Compartment, it is recommended that the Battery be changed in an environment equivalent to the local outdoor temperature and humidity (e.g., do not change the Battery in an air conditioned environment then take it outside during a hot sunny day).

Inspect the Buttons, Lens, and Housing to ensure they are not cracked or damaged. If there is any sign of moisture in the OCS, DO NOT attempt to use it for diving (NORM, GAUG, or FREE) until it receives proper service by the Oceanic factory or an Authorized Regional Distributor.

Data Retention

When the battery is removed, settings and nitrogen/oxygen calculations for repetitive dives will be retained in volatile memory until a new battery is installed. You will have the choice of saving or deleting the data. The Compass will need to be calibrated after the new battery is installed.

All parts needed for the battery change that follows are provided in the OCS Battery Kit available from your Oceanic Dealer.

Battery Removal

- There is no need to remove the straps.
- Remove the (4) retaining screws located on the back of the case (Fig. 165) by turning them counter clockwise with a small flat tip 3mm screw driver.
- Carefully separate the front and back sections. If necessary, insert a small flat tip screw driver in the slot machined into the Cover at the 11 o'clock position (Fig. 166A) and gently pry the Battery Cover loose, then lift it off the case (Fig. 166B).
- Turn the case to one side to drop the Battery into your hand. If necessary, gently loosen it with the tip of your finger (Fig. 167). DO NOT use tools to pry it out, or short the positive (+) top of the Battery to the negative (-) contact under it.
- Discard the Battery according to local regulations governing disposal of Lithium batteries.



Fig. 165 - CASE BACK



Fig. 166A - TO LOOSEN BATTERY COVER



Fig. 166B - LIFTING BATTERY COVER OFF



Fig. 167 - BATTERY REMOVAL

Inspection

- Closely check all of the sealing surfaces for any signs of damage that might impair proper sealing.
- Inspect the buttons, lens, and housing to ensure they are not cracked or damaged.

⚠ WARNING: If damage or corrosion is found, return your OCS to an Authorized Oceanic Dealer, and DO NOT attempt to use it until it has received factory prescribed service.

- Remove the cover O-ring by squeezing the sides (Fig. 168a). Discard, and do not attempt to reuse it.
 - > It is located around the top rim of the cover.
 - > DO NOT use tools to remove the O-ring.
 - > To ensure proper sealing, O-ring replacement is required each time the Battery is replaced.

Battery Installation

- Very lightly lubricate the new O-ring with silicone grease and place it on the top rim of the cover.
- Place a new 3 volt type CR2450 Lithium Battery, negative side down into the Battery cavity and ensure that it is evenly positioned (Fig. 169).
- Carefully position the Battery Cover over the battery compartment. Use the OCS logo as a guide for top/bottom. Also, small symbols have been engraved on the top of the Cover and strap to serve as a guide for proper alignment (Fig. 170a).
- While ensuring that the cover and back of the case are properly aligned, firmly press them evenly and completely together.
- While holding the Battery Cover firmly in position against the back of the case (Fig. 171), insert the (4) retaining screws and tighten them until secure by turning them clockwise with a small flat tip 3mm screw driver. DO NOT over tighten.

Testing

- > Activate the unit and ensure that the LCD is clear and sharp in contrast. If any portions are missing or appear dim, or if a Low Battery condition is indicated, return the OCS to an Authorized Oceanic Dealer for evaluation before use.
- > During 24 hours after completion of a dive, the graphic DATA with selections SAVE ? and CLEAR ? will be displayed (Fig. 172) giving you the option to retain or delete Ni-O2 calculations for repetitive dives.
- A (< 2 sec) to toggle between SAVE and CLEAR
- S (< 2 sec) to save the selection
- > Graphics DATA SAVED (or CLEARED) with CAL COMPASS appear for 3 seconds (Fig. 173), then operation reverts to the Compass CAL screen.
- > Calibrate the Compass.
- > Verify all Set Points prior to diving.

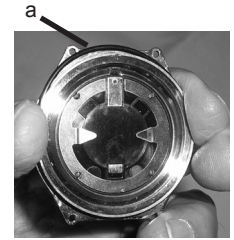

Fig. 168 - SQUEEZING COVER O-RING



Fig. 169 - INSTALLING BATTERY

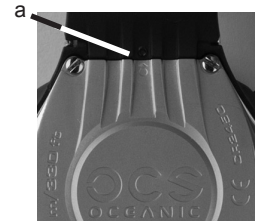

Fig. 170 - BATTERY COVER ALIGNMENT



Fig. 171 - PRESSING FRONT & BACK TOGETHER



Fig. 172 - SELECT



Fig. 173 - DATA SAVED

ALTITUDE SENSING AND ADJUSTMENT

Prior to the first dive of a series of repetitive dives, Altitude (i.e., ambient pressure) is measured upon activation of Dive Surface Mode and every 15 minutes until a dive is made or operation reverts to Watch Mode.

- > While it is operating in Watch modes after a dive, measurements are taken every 15 minutes during the 24 hour period after surfacing.
- > Measurements are only taken when the unit is dry.
- > Two readings are taken, the second reading 5 seconds after the first. The readings must be within 1 foot (30 cm) of each other to record that ambient pressure as the current Altitude.
- > No adjustments are made during any time that the Wet Contacts are bridged.

When diving in high altitude waters from 3,001 to 14,000 feet (916 to 4,270 meters), the OCS automatically adjusts to these conditions providing corrected Depth, and reduced No Deco and O2 Times at intervals of 1,000 feet (305 meters).

At an elevation of 3,001 feet (916 meters), Depth calibration automatically changes from feet of seawater to feet of fresh water. This is the first adjustment to the algorithm.

When the Conservative Factor feature is set On, NDLs are calculated based upon the next higher 3,000 foot (915 meter) Altitude. All adjustments for Altitudes greater than 11,000 feet (3,355 meters) are then made to allowable dive times for 14,000 feet (4,270 meters). At Sea Level, calculations are based upon an Altitude of 6,000 feet.

The OCS will not function as a Dive Computer above 14,000 feet (4,270 meters).

TECHNICAL DATA

PZ+ ALGORITHM >> NDLS (HR:MIN) AT ALTITUDE (IMPERIAL)

Altitude (feet)	0 to 3000	3001 to 4000	4001 to 5000	5001 to 6000	6001 to 7000	7001 to 8000	8001 to 9000	9001 to 10000	10001 to 11000	11001 to 12000	12001 to 13000	13001 to 14000
Depth (FT)												
30	3:17	2:30	2:21	2:14	2:08	2:02	1:57	1:52	1:47	1:39	1:34	1:29
40	1:49	1:21	1:15	1:11	1:08	1:05	1:02	1:00	0:57	0:55	0:53	0:51
50	1:05	0:53	0:51	0:49	0:47	0:44	0:42	0:39	0:37	0:35	0:34	0:33
60	0:48	0:37	0:35	0:33	0:32	0:30	0:28	0:26	0:24	0:23	0:22	0:21
70	0:35	0:26	0:24	0:23	0:21	0:20	0:19	0:18	0:17	0:16	0:16	0:14
80	0:26	0:19	0:18	0:17	0:16	0:15	0:14	0:13	0:12	0:11	0:11	0:10
90	0:19	0:15	0:14	0:13	0:12	0:11	0:10	0:10	0:09	0:09	0:08	0:08
100	0:16	0:11	0:10	0:10	0:09	0:09	0:08	0:08	0:07	0:07	0:07	0:07
110	0:12	0:09	0:08	0:08	0:08	0:07	0:07	0:07	0:06	0:06	0:06	0:05
120	0:10	0:08	0:07	0:07	0:07	0:06	0:06	0:06	0:05	0:05	0:05	0:05
130	0:08	0:07	0:06	0:06	0:06	0:05	0:05	0:05	0:05	0:05	0:04	0:04
140	0:07	0:06	0:05	0:05	0:05	0:05	0:05	0:04	0:04	0:04	0:04	0:04
150	0:06	0:05	0:05	0:05	0:05	0:04	0:04	0:04	0:04	0:04	0:04	0:03
160	0:06	0:05	0:05	0:04	0:04	0:04	0:04	0:04	0:04	0:03	0:03	0:03
170	0:05	0:04	0:04	0:04	0:04	0:04	0:03	0:03	0:03	0:03	0:03	0:03
180	0:05	0:04	0:04	0:04	0:03	0:03	0:03	0:03	0:03	0:03	0:03	0:03
190	0:04	0:04	0:04	0:03	0:03	0:03	0:03	0:03	0:03	0:03	0:03	0:03

PZ+ ALGORITHM >> NDLS (HR:MIN) AT ALTITUDE (METRIC)

Altitude (meters)	0 to 915	916 to 1220	1221 to 1525	1526 to 1830	1831 to 2135	2136 to 2440	2441 to 2745	2746 to 3050	3051 to 3355	3356 to 3660	3661 to 3965	3966 to 4270
Depth (M)												
9	3:37	2:41	2:31	2:23	2:16	2:10	2:04	1:59	1:54	1:50	1:43	1:37
12	1:55	1:27	1:21	1:15	1:12	1:08	1:05	1:03	1:00	0:58	0:55	0:54
15	1:08	0:55	0:53	0:51	0:49	0:47	0:44	0:42	0:39	0:37	0:36	0:34
18	0:50	0:39	0:37	0:35	0:33	0:32	0:30	0:28	0:26	0:24	0:23	0:22
21	0:36	0:28	0:26	0:24	0:23	0:21	0:20	0:19	0:18	0:17	0:16	0:16
24	0:27	0:20	0:19	0:18	0:17	0:16	0:15	0:14	0:13	0:12	0:11	0:11
27	0:20	0:16	0:15	0:13	0:12	0:11	0:11	0:10	0:09	0:09	0:09	0:08
30	0:16	0:12	0:11	0:10	0:09	0:09	0:08	0:08	0:07	0:07	0:07	0:07
33	0:13	0:09	0:09	0:08	0:08	0:07	0:07	0:07	0:07	0:06	0:06	0:06
36	0:10	0:08	0:07	0:07	0:07	0:06	0:06	0:06	0:05	0:05	0:05	0:05
39	0:09	0:07	0:06	0:06	0:06	0:06	0:05	0:05	0:05	0:05	0:05	0:04
42	0:08	0:06	0:06	0:05	0:05	0:05	0:05	0:05	0:04	0:04	0:04	0:04
45	0:06	0:05	0:05	0:05	0:05	0:04	0:04	0:04	0:04	0:04	0:04	0:04
48	0:06	0:05	0:05	0:04	0:04	0:04	0:04	0:04	0:04	0:04	0:03	0:03
51	0:05	0:04	0:04	0:04	0:04	0:04	0:04	0:03	0:03	0:03	0:03	0:03
54	0:05	0:04	0:04	0:04	0:04	0:03	0:03	0:03	0:03	0:03	0:03	0:03
57	0:05	0:04	0:04	0:03	0:03	0:03	0:03	0:03	0:03	0:03	0:03	0:03

DSAT ALGORITHM >> NDLS (HR:MIN) AT ALTITUDE (IMPERIAL)

Altitude (feet)	0 to 3000	3001 to 4000	4001 to 5000	5001 to 6000	6001 to 7000	7001 to 8000	8001 to 9000	9001 to 10000	10001 to 11000	11001 to 12000	12001 to 13000	13001 to 14000
Depth (FT)												
30	4:20	3:21	3:07	2:55	2:45	2:36	2:28	2:21	2:15	2:10	2:04	1:58
40	2:17	1:43	1:36	1:30	1:25	1:20	1:16	1:12	1:09	1:06	1:03	1:01
50	1:21	1:03	1:00	0:58	0:55	0:52	0:48	0:45	0:43	0:41	0:39	0:37
60	0:57	0:43	0:40	0:38	0:36	0:34	0:33	0:31	0:30	0:29	0:28	0:27
70	0:40	0:31	0:30	0:28	0:27	0:26	0:24	0:23	0:22	0:20	0:19	0:18
80	0:30	0:24	0:23	0:21	0:20	0:19	0:18	0:17	0:16	0:16	0:14	0:13
90	0:24	0:19	0:18	0:17	0:16	0:15	0:14	0:13	0:12	0:11	0:10	0:10
100	0:19	0:15	0:14	0:13	0:12	0:11	0:10	0:10	0:09	0:09	0:08	0:08
110	0:16	0:12	0:11	0:10	0:09	0:09	0:08	0:08	0:08	0:07	0:07	0:07
120	0:13	0:09	0:09	0:08	0:08	0:08	0:07	0:07	0:07	0:06	0:06	0:06
130	0:11	0:08	0:08	0:07	0:07	0:07	0:06	0:06	0:06	0:06	0:05	0:05
140	0:09	0:07	0:07	0:06	0:06	0:06	0:06	0:05	0:05	0:05	0:05	0:05
150	0:08	0:06	0:06	0:06	0:05	0:05	0:05	0:05	0:05	0:04	0:04	0:04
160	0:07	0:06	0:05	0:05	0:05	0:05	0:05	0:04	0:04	0:04	0:04	0:04
170	0:07	0:05	0:05	0:05	0:04	0:04	0:04	0:04	0:04	0:04	0:04	0:03
180	0:06	0:05	0:05	0:04	0:04	0:04	0:04	0:04	0:04	0:03	0:03	0:03
190	0:05	0:04	0:04	0:04	0:04	0:04	0:04	0:03	0:03	0:03	0:03	0:03

DSAT ALGORITHM >> NDLS (HR:MIN) AT ALTITUDE (METRIC)

Altitude (meters)	0 to 915	916 to 1220	1221 to 1525	1526 to 1830	1831 to 2135	2136 to 2440	2441 to 2745	2746 to 3050	3051 to 3355	3356 to 3660	3661 to 3965	3966 to 4270
Depth (M)												
9	4:43	3:37	3:24	3:10	2:58	2:48	2:39	2:31	2:24	2:18	2:12	2:07
12	2:24	1:52	1:44	1:37	1:30	1:25	1:21	1:17	1:13	1:10	1:07	1:04
15	1:25	1:06	1:03	1:00	0:57	0:55	0:52	0:49	0:46	0:43	0:41	0:39
18	0:59	0:45	0:42	0:40	0:38	0:36	0:34	0:32	0:31	0:30	0:29	0:28
21	0:41	0:33	0:31	0:29	0:28	0:27	0:26	0:24	0:23	0:21	0:20	0:19
24	0:32	0:26	0:24	0:22	0:21	0:20	0:19	0:18	0:17	0:16	0:15	0:14
27	0:25	0:19	0:18	0:17	0:16	0:16	0:14	0:13	0:12	0:12	0:11	0:10
30	0:20	0:16	0:15	0:13	0:12	0:12	0:11	0:10	0:10	0:09	0:09	0:08
33	0:17	0:12	0:11	0:11	0:10	0:09	0:09	0:08	0:08	0:08	0:07	0:07
36	0:14	0:10	0:09	0:09	0:08	0:08	0:07	0:07	0:07	0:06	0:06	0:06
39	0:11	0:08	0:08	0:07	0:07	0:07	0:06	0:06	0:06	0:06	0:05	0:05
42	0:09	0:07	0:07	0:07	0:06	0:06	0:06	0:05	0:05	0:05	0:05	0:05
45	0:08	0:06	0:06	0:06	0:06	0:05	0:05	0:05	0:05	0:05	0:04	0:04
48	0:07	0:06	0:06	0:05	0:05	0:05	0:05	0:04	0:04	0:04	0:04	0:04
51	0:06	0:05	0:05	0:05	0:05	0:04	0:04	0:04	0:04	0:04	0:04	0:04
54	0:06	0:05	0:05	0:04	0:04	0:04	0:04	0:04	0:04	0:03	0:03	0:03
57	0:05	0:04	0:04	0:04	0:04	0:04	0:04	0:03	0:03	0:03	0:03	0:03

SPECIFICATIONS

CAN BE USED AS

- Watch
- Dive Computer (Air or Nitrox)
- Digital Depth Gauge/Timer
- Free Dive activity
- Compass

DIVE COMPUTER PERFORMANCE

- Buhlmann ZHL-16c based PZ+, or DSAT based, algorithm
- No Deco limits closely follow PADI RDP
- Decompression in agreement with Buhlmann ZHL-16c and French MN90
- No Deco Deep Stops - Marroni, Bennett
- Deco Deep Stops (not recommended) - Blatteau, Gerth, Gutvik
- Altitude - Buhlmann, IANTD, RDP (Cross)
- Altitude corrections and O2 limits based on NOAA tables

OPERATIONAL PERFORMANCE

Function: Accuracy:
 • Depth ±1% of full scale
 • Timers 1 second per day

Dive Mode Activation:

- Must be in Dive Computer mode, if Wet Activation is set OFF.
- Automatic by immersion in water, if Wet Activation is set ON.
- Cannot be manually activated deeper than 5 FT (1.5 M), if Water Activation is set OFF.
- Cannot operate as a DC at elevations higher than 14,000 feet (4,270 meters)

Dive Counter:

- NORM/GAUG displays Dives #1 to 24, FREE displays #1 to 99 (0 if no dive made yet)
- Resets to Dive #1, upon diving (after 24 hours with no dives)

Dive Log Mode:

- Stores 24 most recent NORM/GAUG dives in memory for viewing
- After 24 dives, adds 25th dive in memory and deletes the older dive

Altitude:

- Operational from sea level to 14,000 feet (4,270 meters) elevation
- Measures ambient pressure every 30 minutes in Watch Mode, when Dive Computer Mode is accessed, and every 15 minutes while in NORM/GAUG/FREE Surface Modes.
- Does not measure ambient pressure when Wet.
- Compensates for Altitudes above sea level beginning at 3,001 feet (916 meters) elevation and every 1,000 feet (305 meters) higher.

Power:

- Battery (1) 3 vdc, CR2450, Lithium battery (Panasonic or equivalent)
- Shelf life Up to 7 years (when shipped from factory in Deep Sleep mode)
- Replacement User replaceable (annual recommended)
- Use Life 1 year or 300 dive hours if (2) 1 hour dives per dive day

Battery Icon:

- Warning >> icon on solid when <= 2.75 volts, Battery change recommended
- Alarm >> icon on flashing when <= 2.50 volts, change the Battery, will not function as a DC

Operating Temperature:

- Out of the water >> between 20 °F and 140 °F (-6 and 60 °C).
- In storage case provided >> between 14 °F and 158 °F (-8 and 70 °C).
- In the water >> between 28 °F and 95 °F (-2 and 35 °C).

BAR GRAPHS

TLBG segments **O2BG** segments

- No Deco Normal zone 3 • Normal zone 3
- No Deco Caution zone 1 • Caution zone 1
- Decompression zone 1 • Danger zone 1

VARI 60 FT (18 M) & Shallower Deeper than 60 FT (18 M)

	60 FT (18 M) & Shallower			Deeper than 60 FT (18 M)		
	segments	FPM	MPM	segments	FPM	MPM
	0	0 - 10	0 - 3	0	0 - 20	0 - 6
• Normal Zone	1	11 - 25	3.5 - 7.5	1	21 - 50	6.5 - 15
• Caution Zone	2	26 - 30	8 - 9	2	51 - 60	15.5 - 18
• Too Fast Zone (flashing)	3 (all)	> 30	> 9	3 (all)	> 60	> 18

SPECIFICATIONS (CONTINUED)

NUMERIC DISPLAYS:	Range:	Resolution:
• Watch Time of Day	0:00:00 to 23:59:59 hr:min.sec	1 second
• Watch Alternate Time	0:00:00 to 23:59:59 hr:min.sec	1 second
• Watch Time Differential	- 23 hr to 0 to + 23 hr	1 hour
• Watch Countdown Timer	23:59 to 0:00 hr:min	1 minute
• Watch Chrono Lap #	1 to 9	1 (Lap)
• Watch Chrono Lap Time	0:00:00.00 to 99:59:59.99 hr:min:sec_.01 sec	.01 second
• PC Countdown Timer	1:59 to 0:00 min:sec	1 second
• Altitude Level	Sea, EL 2 to EL 7	1 (level)
• Time to Fly	23:50 to 0:00 hr:min (starting 10 min after the dive)	1 minute
• Time to Desat	23:50 to 0:00 hr:min (starting 10 min after the dive)	1 minute
• Temperature	0 to 140°F (-9 to 60°C)	1°F (C)
• Max Operating Depth	330 FT (100 M)	
• NORM/GAUG SI Time	0:00 to 23:59 hr:min	1 minute
• NORM/GAUG Dive Number	0 to 24	1
• NORM Depth (display)	0 to 330 FT (100 M)	1 FT (0.1/1 M)
• GAUG Depth (display)	0 to 660 FT (200 M)	1 FT (0.1/1 M)
• NORM/GAUG EDT	0:00 to 9:59 hr:min	1 minute
• NORM DTR (NDC, OTR)	0:00 to 9:59 hr:min	1 minute
• FO2 Set Points (Gas 1, 2, 3)	Air, 21 to 100 %	1 %
• PO2 Value (Gas, 1, 2, 3)	0:00 to 5:00 ATA	.01 ATA
• No Deco Deep Stop Time	2:00 to 0:00 min:sec	1 second
• No Deco Safety Stop Time	5:00 to 0:00 min:sec	1 second
• Deco Stop Time	0:00 to 9:59 hr:min	1 minute
• Total Ascent Time	0:00 to 9:59 hr:min	1 minute
• Violation Countdown Timer	23:50 to 0:00 hr:min	1 minute
• FREE SI Time	0:00 to 59:59 min:sec 1:00 to 23:59 hr:min	1 second 1 minute
• FREE Dive Number	0 to 99	1
• FREE Countdown Timer	59:59 to 0:00 min:sec	1 second
• FREE EDT	0:00 to 59:59 min:sec	1 second



WARNING: If your OCS stops working for any reason while operating as a Dive Computer, it is important that you have anticipated this possibility and are prepared for it. This is an important reason for not pushing the no decompression and oxygen exposure limits, and a critical reason to avoid entering decompression.

If you dive in situations where your trip would be ruined or your safety would be jeopardized by losing the use of your OCS, a backup instrument system is highly recommended.

INSPECTION / SERVICE RECORD

OCS Serial Number: _____

OCS Firmware Rev: _____

Date of Purchase: _____

Purchased from: _____

Below to be filled in by an Authorized Oceanic Dealer:

Date	Service Performed	Dealer/Technician

OCEANIC WORLD WIDE

OCEANIC USA
 2002 Davis Street
 San Leandro, CA 94577
 Tel: 510/562-0500
 Fax: 510/569-5404
 Web: www.OceanicWorldwide.com
 E-mail: hello@oceanicusa.com

OCEANIC EUROPE
 Augsburg, Germany
 Tel: +49 (0) 821 810342 0 Fax: +49 (0) 821 810342 29
 Web: www.oceanic-eu.com
 E-mail: office@oceanic.de

OCEANIC AUSTRALIA
 Rosebud, Victoria, Australia
 Tel: 61-3-5986-0100 Fax: 61-3-5986-1760
 Web: www.OceanicAUS.com.au
 E-mail: sales@OceanicAUS.com.au

OCEANIC UK
 Devon, United Kingdom
 Tel: (+44) 1404-891819 Fax: +44 (0) 1404-891909
 Web: www.OceanicUK.com
 E-mail: helpyou@oceanicuk.com

OCEANIC ASIA PACIFIC
 Singapore
 Tel: +65-6391-1420 Fax: +65-6297-5424
 E-mail: info@oceanicasia.com.sg

OCEANIC HAWAII and MICRONESIA
 Kapolei, Hawaii
 Tel: 808-682-5488 Fax: 808-682-1068
 E-mail: lbell@oceanicusa.com

OCS
DIVE COMPUTER
OPERATING MANUAL